

**NOTE:** Before programming the opener, check to make sure there are no objects in the garage door opening. DO NOT allow persons to enter the area of the door while programming and operating.

The following steps list the order of programming the opener's functional settings and install any accessories that were included with the opener or purchased separately. These steps should be performed in order.

1. Down Travel Limit
2. Up Travel Limit
3. Force Control
4. Contact Reverse test and adjustment
5. Remote Control Programming
  - Remote control(s) included with this opener are programmed at the factory. The information provided on this page should be used if adding additional remote controls.
6. Accessory Programming
  - Program wireless keypad (If applicable)
  - Program built in vehicle remote (If applicable)
  - Program the Integrated Aladdin Connect (if applicable)
7. Install Battery Backup (If applicable)

#### Term Definitions:

**Travel Limits** Programmable setting to adjust how far door travels up or down.

**Force Control** refers to how much power is needed to move (open/close) a particular door and does NOT require programming.

**Remote & Accessory Programming** synchronizes remote devices with the powerhead. (Remote Controls, Wireless Keypad, Homelink®, Car-2-U® Systems)

**Speed Control** refers to how fast or slow the opener opens and closes the door. This is factory set and does NOT require programming. NOT available on all models.

#### Programming Button Layout

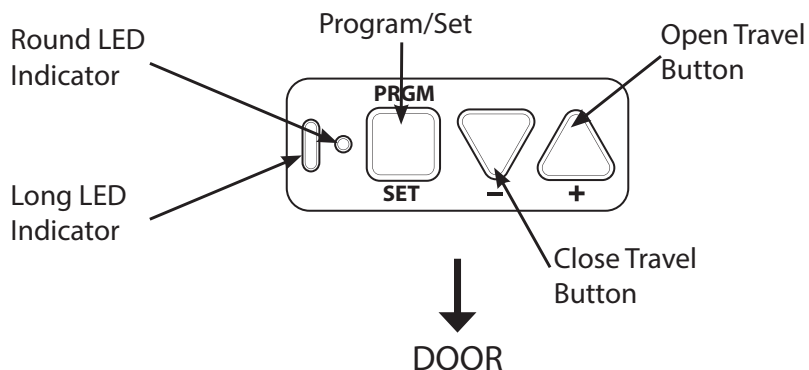

**NOTE:** Each programming step has a 30 second time limit for completion after the function is initiated. After 30 seconds, both LED's will illuminate RED indicating time has expired and the step must be restarted. Restart the step as many times as necessary to complete the programming.

# PROGRAMMING DOWN TRAVEL LIMIT

## ⚠ WARNING

- Make sure doorway is in full view and clear of obstacles and people to avoid injury or property damage.
- DO NOT operate this unit from the wall control before LIMITS are set. Severe damage to the opener could occur.
- The carriage MUST be engaged to turnbuckle BEFORE setting limits. See installation poster or call Customer Service at 1-800-35-GENIE or visit [www.geniecompany.com](http://www.geniecompany.com).
- DO NOT set limits with Battery Backup attached. AC power MUST be connected to the opener while setting limits for proper operation.

## ⚠ AVERTISSEMENT

- S'assurer que le passage de la porte est visible et dégagé, à savoir sans obstacles ni personne afin d'éviter toute blessure potentielle ou dommage matériel.
- NE PAS utiliser cette unité avec la console murale avant d'avoir réglé les LIMITES. L'ouvre-porte pourrait subir de sérieux dommages.
- La tendeur DOIT être engagée dans le chariot AVANT de régler les limites. Voir le poster d'installation (si fourni) ou appelez le service clientèle au 1-800-35-GENIE ou visitez le site [www.geniecompany.com](http://www.geniecompany.com).
- NE PAS fixer de limites en mode batterie de secours. L'alimentation CA DOIT être branchée sur l'ouvre-porte, pendant le réglage des limites, pour assurer un bon fonctionnement.

**⚠ NOTE:** Door MUST be locked to the opener prior to programming. Door should rest somewhere between full open and closed. Do not start with door fully open or closed. (SEE INSET ABOVE RIGHT)

### Programming DOWN Limit:

1. Press and hold the DOWN arrow button.
  - Long LED will light BLUE.
2. Release DOWN arrow button.
  - Long LED will flash BLUE.
3. Press and hold the DOWN arrow button until door is fully closed.
  - Use the UP arrow button if door closes too far. Use both UP and DOWN buttons to adjust close travel as necessary.

*Door should rest on the floor until the weather strip is compressed enough to seal along the width of the door. Damaged doors or uneven floors may not seal properly. Repair these conditions to achieve a proper seal. DO NOT compress seal so much that the door will bend or buckle.*

4. Press and release the SET/PRGM button
  - Both LEDs will flash BLUE then go out.

The DOWN limit is now programmed.

**TO ENGAGE DOOR TO CARRIAGE:**  
Lift door by hand until carriage engages the shuttle on screwdrive or the bullet on the chain/belt systems.

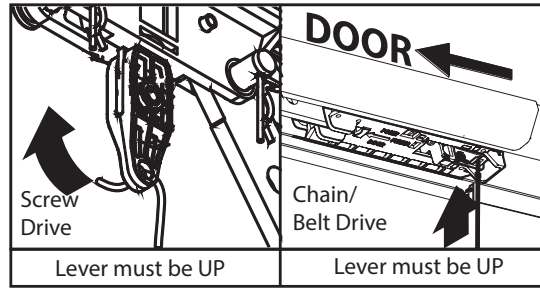

### 1-2. Enter Programming Mode

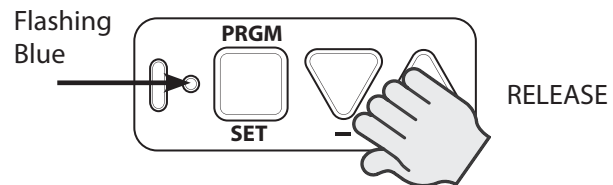
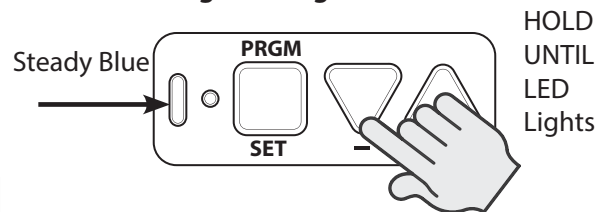

### 3. Adjust Door Position

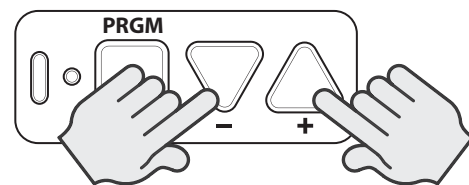

### 4. Lock Programming

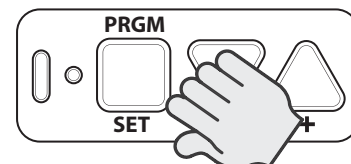
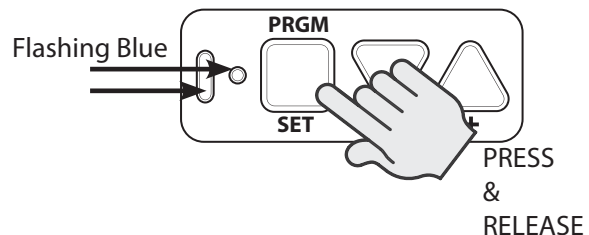

# PROGRAMMING UP TRAVEL LIMIT

## Programming UP Limit:

1. Press and hold the UP arrow button.
  - Long LED will light BLUE.
2. Release UP arrow button.
  - Round LED will flash BLUE.
3. Press and hold the UP arrow button until door is fully open.
  - Use the DOWN arrow button if door opens too far. Use both UP and DOWN buttons to adjust open travel as necessary.

## SECTIONAL DOOR UP LIMIT:

Door should fully open so that door seal is even with door header. Do not adjust so much that the door will bend, buckle or stretch door spring cables backward. Stop carriage short of the opener powerhead.

## ONE-PIECE DOOR UP LIMIT:

Door should fully open so that the door arms will be in line and push forward and up on the door.

**Door damage can result** if up limit is set too far back and door arms are angled downward pushing against the natural travel direction. Fig. A

Door should fully open so that door seal is even with door header. Do Not adjust so much that the door will bend or buckle or stretch door spring cables backward.

4. Press and release the SET/PRGM button
  - Both LEDs will flash BLUE then go out.

*The UP limit is now programmed.*

## One-Piece Door Limit Setting

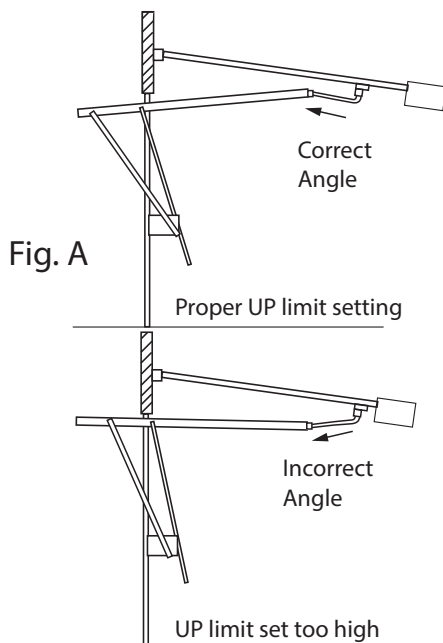

## 1-2. Enter Programming Mode

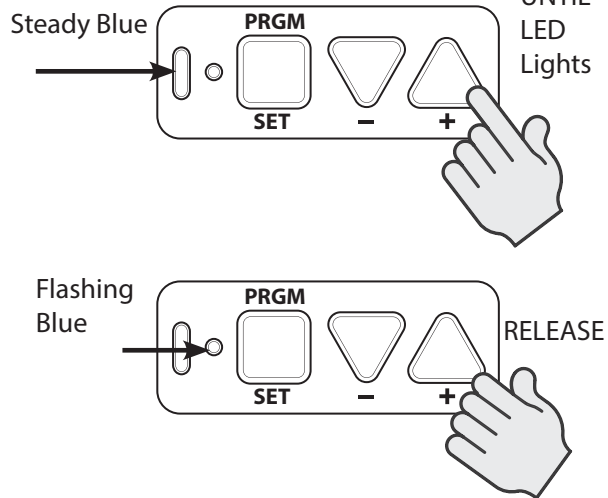

## 3. Adjust Door Position

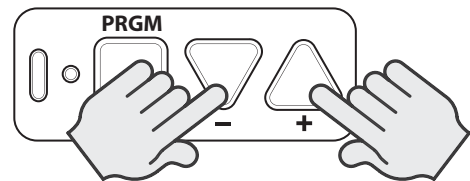

## 4. Lock Programming

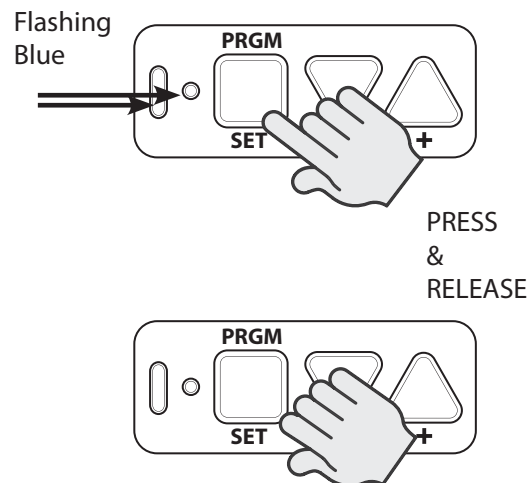

# PROGRAMMING FORCE AND CONTACT REVERSE

## Force Control

The force controls are automatically set when the wall control is used for the first time with garage door opener. The door **MUST** complete one full cycle, from full open to full close and then, full close to full open, before the settings are automatically recorded.

### **WARNING**

#### TO AVOID INJURY OR DAMAGE

- **NEVER** adjust the force settings to adjust for damage, including an unbalanced door, binding door track or broken spring.
- Perform a CONTACT REVERSE TEST monthly.

### **AVERTISSEMENT**

#### Pour éviter les blessures ou des dommages

- **NE JAMAIS** régler la force pour compenser des dommages, y compris une porte mal équilibrée, un rail de porte coinçant ou des ressorts cassés.
- Tous les mois, EFFECTUEZ LE TEST D'INVERSION AU CONTACT.

1. Press and release the Wall Control button and allow the garage door to travel and stop at the DOWN limit.
2. Press and release the wall control button and allow the garage door to travel and stop at the UP limit.

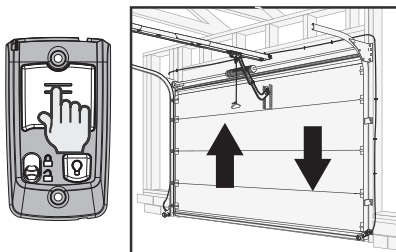

## Force Control Adjustments

*Force settings are programmed from the factory to remain within safe parameters. These should not require adjustments. However, certain circumstances may require adjustment.*

Refer to the "Maintenance and Adjustment" section, page 17, to adjust the force settings.

## Contact Reverse Test

**NOTE:** The limit and Force settings **MUST BE COMPLETED** before performing the Contact Reverse Test.

1. With the garage door open, lay a 2 X 4 board flat on the floor at the center of the door opening.
2. Close the garage door using the wall control.

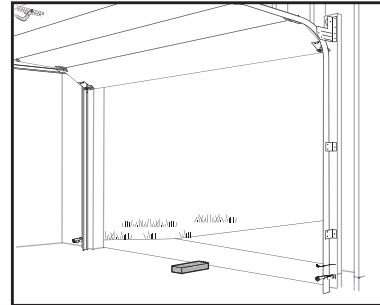
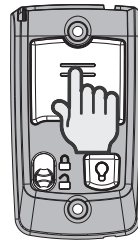

- When the door contacts the board, it should stop and reverse direction within 2 seconds to the full open position.
- The long LED light on the powerhead will begin to flash RED with the reversal of the door.
- Remove the 2" x 4" board and operate the opener with the wall control again. This cycle will clear the flashing red LEDs.

## Contact Reverse Adjustment

If the door stops before contacting the board or if it does not reverse direction to fully open after contact with the board, it may be due to an improperly set DOWN limit. Verify settings by:

1. Repeat the "Down Travel Limit" section to make certain the door is closing tight against the floor.
2. Repeat the "Force Control" section on the left to set force limits.
3. Repeat the "Contact Reverse Test" above.

Repeat this process as needed until the door passes the Contact Reverse Test.

Refer to the "Maintenance and Adjustment" section, page 17, to adjust the force settings.

# PROGRAMMING ADDITIONAL REMOTE CONTROLS

**THE REMOTE CONTROLS INCLUDED WITH THIS OPENER HAVE BEEN PROGRAMMED AT THE FACTORY FOR YOUR CONVENIENCE.**

**NOTE:** The following instructions are for remote control transmitters purchased separately in addition to those provided with this opener, but can also be used if any remote(s) may require re-programming.

**NOTE:** Each programming step has a 30 second time limit for completion after the function is initiated. After 30 seconds, two LED's will illuminate RED indicating time has expired and the step must be re-started. Restart the step as many times as necessary to complete the programming.

**NOTE:** Do not hold remote too close to the powerhead when programming remote buttons.

**NOTE:** Each button on each remote must be programmed separately, following these steps.

1. Remove the battery's protective film from the remote by pulling straight down.
2. Press and hold the SET/PRGM button on the opener for two seconds.
  - The ROUND LED will turn BLUE.
  - The LONG LED will then flash PURPLE.
3. Stand at least 5 feet away from opener and slowly press and release the desired button on the remote two times.
  - Both opener LEDs will flash and turn off indicating the remote has been programmed.
4. Press the desired remote button again.
  - The opener should run.

To program the same remote for other garage door opener, repeat the steps above using one of the other remaining remote buttons.

## REPEAT STEPS 1 TO 4 FOR EACH OPENER AND REMOTE

**NOTE:** It is possible to press the remote button too quickly or lightly. If the LEDs do not go off, press the remote button several more times to achieve confirmation.

**BASIC PROGRAMMING IS COMPLETE AND YOUR GARAGE DOOR OPENER IS READY TO USE.**

See page 18 of this manual to erase remote devices from memory.

## 1. Activate Remote



## 2. Enter Programming Mode

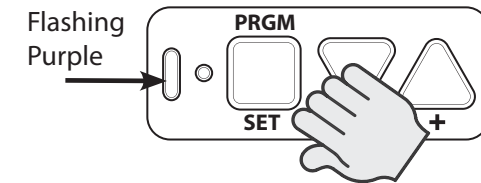
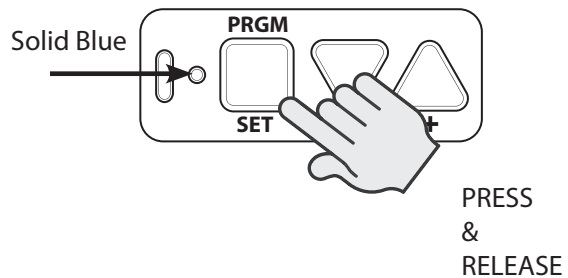

## 3. Press Remote Button Twice

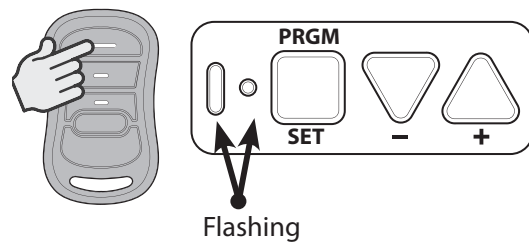

## 4. Test Remote

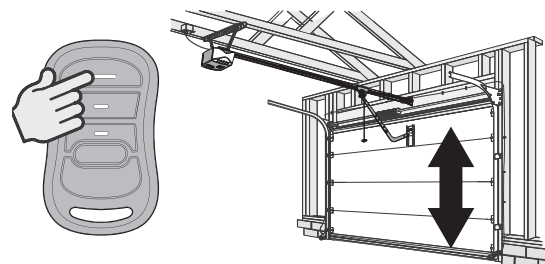

# PROGRAMMING KEYPAD (abbreviated)

## QuickView Single Door setup.

Please see complete instructions that accompany keypad

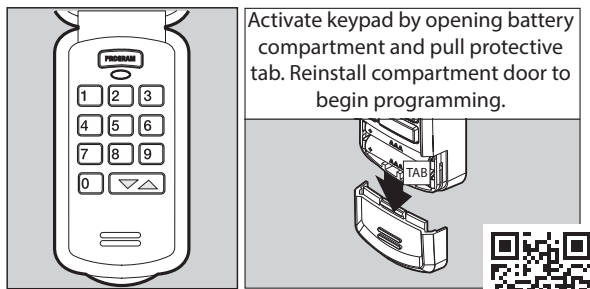

Scan Code for a video of the complete installation and programming.



## Program Keypad before mounting.

### STEP 1) PROGRAMMING A PIN NUMBER (Single Door)

Program the keypad for the first time\* with a Personal Identification Number (PIN). This PIN must be 3 to 8 digits.

1. Ensure number pad back lighting is off.
2. Press 3-5-7 in sequence.
3. Press PROGRAM key. LED will blink once per second.
4. Enter a PIN number (3-8 digits).
5. Press PROGRAM key. LED will blink twice and shut off.

### STEP 2) PROGRAMMING THE KEYPAD TO 1 OPENER

1. Place garage door opener into PROGRAMMING MODE.
2. Ensure number pad back lighting is off.
3. Enter the PIN number on keypad.
4. Press the UP/DOWN key 3 to 4 times slowly until garage door opener operates.

### PUTTING OPENER INTO PROGRAMMING MODE:

1. Press and hold the program button on the powerhead until the round LED turns blue, then release.
2. The round LED will go out and the long LED will begin flashing purple.
3. Complete programming steps.

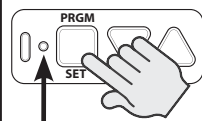

Solid Blue

PRESS  
&  
RELEASE

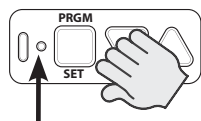

Flashing Purple

**NOTE:** The openers LEARN LED will time out in 30 seconds. Programming must be completed within 30 seconds.

### STEP 3) OPERATING THE KEYPAD WITH THE OPENER

#### Single Door Operation:

1. Ensure number pad back lighting is off.
2. Enter PIN number.
3. Press the UP/DOWN key.
4. Opener will operate.

**NOTE:** Keypad will remain active for 15 seconds after a successful entry is made. During this 15 seconds ANY key will operate the opener.

#### Resetting a PIN:

Press and hold both the **PROGRAM** key and the Up/Down key for about five seconds.

The LED's will slowly blink and then go out. When the LED stops blinking, the old programming has been successfully erased.

To create a new PIN, start with "Setting the PIN for the First Time"

## Mounting Keypad

The keypad **MUST** be mounted within sight of the garage door(s) at least five feet above the floor and clear of any moving door part.

1. Remove battery cover and batteries.

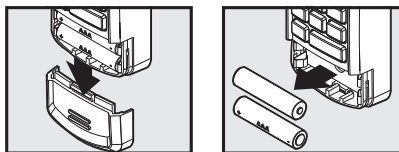

2. Drill 3/32" pilot hole for the top mounting screw (included).
3. Install a screw into the pilot hole, leaving a 1/8" gap between the screw head and wall.

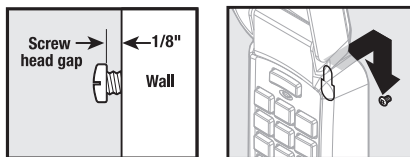

4. Hook the slotted mount, on back of keypad, over the screw.

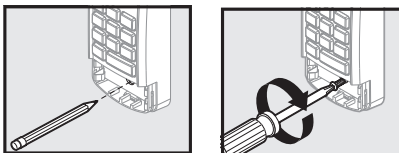

5. Mark and drill a pilot hole for the bottom screw (included) and secure keypad to wall (DO NOT overtighten).
6. Reinstall batteries and cover.

# PROGRAMMING VEHICLE SYSTEMS

## Programming HomeLink® System

### Step 1 Clear HomeLink

Clear HomeLink by pressing and holding down the first and third buttons until the indicator on the HomeLink blinks slow and then fast for 20 seconds; then release both buttons.

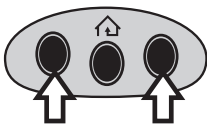

**NOTE:** Clearing the HomeLink will remove all previously programmed garage door openers.

### Step 2 Train HomeLink to the Genie Remote

Choose the button on the HomeLink that will be used to open the door.

**NOTE:** Hold the Genie Remote two inches from the HomeLink button.

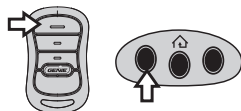

Hold down the Genie remote button. While holding, press and hold the chosen HomeLink button.

Hold down both buttons until the indicator on the HomeLink blinks slow then fast. Once it blinks, release both buttons.

### Step 3 Program HomeLink to the Genie Opener (Place opener into programming mode)

A. Press and hold the **PROGRAM** button on the opener until the round blue LED is ON. Release the button. The long purple LED will begin flashing.

#### PUTTING OPENER INTO PROGRAMMING MODE:

1. Press and hold the program button on the powerhead until the round LED turns blue, then release.
2. The round LED will go out and the long LED will begin flashing purple.
3. Complete programming steps.

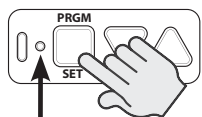

Solid Blue

PRESS  
&  
RELEASE

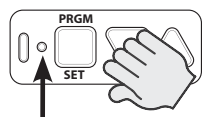

Flashing Purple

**NOTE:** The openers LEARN LED will time out in 30 seconds. Programming must be completed within 30 seconds.

B. Press the chosen HomeLink button for two seconds and release. Press that same button again for two seconds and release. The long LED will flash blue and then turn off.

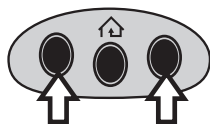

C. Press the HomeLink button a few more times until door moves.

**NOTE:** For additional instructions, see the motor vehicle manual, [www.homelink.com](http://www.homelink.com) or visit [www.GenieCompany.com](http://www.GenieCompany.com)

## Programming Car2U® System

### Step 1 Clear Car2U to default settings

The default setting for the Car2U system is:

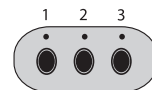

- Button 1 = Genie® Manufactured Openers
- Button 2 = LiftMaster® Manufactured Openers
- Button 3 = Wayne Dalton® Manufactured Openers

- A. Press and hold buttons 1 and 3 for 20 seconds or until all three LEDs begin to flash.
- B. Release both buttons. The Car2U system is now set to the Factory Default settings

**NOTE:** Clearing the Car2U remote will remove all previously programmed garage door openers.

### Step 2 Program Car2U to the Genie Opener (Place opener into programming mode)

- A. Press and hold the **PROGRAM** button on the opener until the round blue LED is ON—release the button. The long purple LED will begin flashing.
- B. Press the designated Genie Car2U button for two seconds and release. Press that same button again for two seconds and release. The long LED will flash blue and then turn off.
- C. Press the Car2U button a few times more until door moves.

#### PUTTING OPENER INTO PROGRAMMING MODE:

1. Press and hold the program button on the powerhead until the round LED turns blue, then release.
2. The round LED will go out and the long LED will begin flashing purple.
3. Complete programming steps.

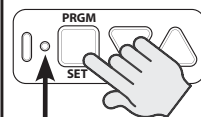

Solid Blue

PRESS  
&  
RELEASE

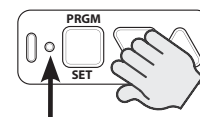

Flashing Purple

**NOTE:** The openers LEARN LED will time out in 30 seconds. Programming must be completed within 30 seconds.

### Step 3 Changing Factory Default Button for a Genie Opener

- A. Press and hold buttons 1 & 3 for **ONE SECOND** and release—all three LEDs will light solid red.
- B. Press and hold the button (2 or 3) to change it to Genie—the corresponding LED will flash. While continuing to hold that button, press and release button 1. Press and release button 1 again.
- C. Release the button being held in step B and wait for the LED to stop flashing. This button is now set for Genie. Repeat Step 2 for second Genie Opener.

**NOTE:** For additional instructions see the motor vehicle manual, [learcar2u.com](http://learcar2u.com) or visit [www.GenieCompany.com](http://www.GenieCompany.com)