

Refer to the assembly poster for opener assembly and installation instructions. Return to this manual for programming, operation and maintenance.

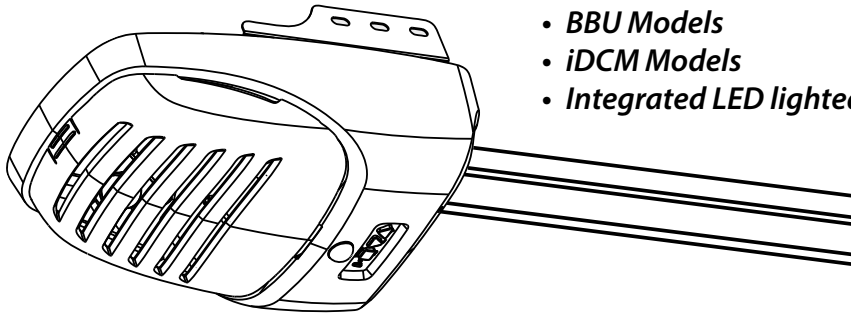

## BELT/CHAIN/SCREW DRIVE GARAGE DOOR OPENER PROGRAMMING, OPERATION & MAINTENANCE MANUAL



- *Standard Models*
- *BBU Models*
- *iDCM Models*
- *Integrated LED lighted Models*

**DO NOT** use photocells from other manufacturers or openers with this opener.

**INSTALLER: LEAVE THIS MANUAL WITH HOMEOWNER**

**HOMEOWNER: SAVE THIS MANUAL FOR FUTURE REFERENCE**

### **WARNING**

To reduce the risk of injury to persons or damage to property, use this opener only with a sectional residential door.

### **AVERTISSEMENT**

Por reduire le risque de blessures ou de dommages materials, utilisez cet ouvre-porte uniquement pour une porte a section re sidentielle.



**DO NOT** return product to store,  
visit [www.geniecompany.com](http://www.geniecompany.com)  
or call Customer Service at: 1-800-35-GENIE

SERIAL NUMBER DECAL

iDCM SERIAL NUMBER DECAL

# INDEX

<b>1</b>	<b>Safety &amp; General Information</b>	
	Introduction .....	1
	Safety Notifications.....	2
	Important Installation Instructions.....	3
<b>2</b>	<b>Standard &amp; Safety Features .....</b>	<b>4</b>
<b>3</b>	<b>Programming Information</b>	
	Introduction to opener programming .....	5
	Setting the DOWN Limit .....	6
	Setting the UP Limit .....	7
	Setting the Force Control .....	8
	Contact Reverse Test .....	8
	Contact Reverse Adjustment .....	8
	Remote Control Programming .....	9
	Keypad Programming* .....	10
	Homelink & Car2U Programming* .....	11
	Integrated Aladdin Programming* .....	12-13
	<b>Maintenance</b>	
<b>4</b>	Important Safety Instructions.....	14
	Regular Maintenance Schedule .....	15
	Door Inspection & Maintenance.....	15
	Remote Battery Replacement.....	16
	Light Bulb Replacement .....	16
	<b>Special Installation Information</b>	
<b>5</b>	Force Adjustment Guide.....	17
	Clearing Remote Memory .....	18
	Use of Dongle Ports* .....	18
	Locating Safe-T-Beam® Pairs .....	19
	Adjusting Speed Control .....	19
	<b>Troubleshooting &amp; LED Signals.....</b>	<b>20-21</b>
<b>6</b>	<b>Replacement Parts .....</b>	<b>22-26</b>
<b>7</b>	<b>DASMA Information .....</b>	<b>28-29</b>
<b>8</b>		



ScrewDrive

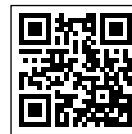

Belt/Chain Drive

Scan this code for a video of this installation or visit: [www.geniecompany.com](http://www.geniecompany.com)

#### **FCC Part 15.21 Statement:**

**Changes or modifications not expressly approved by the party responsible for compliance could void the user's authority to operate the equipment.**

#### **FCC / IC Statement:**

**This device complies with FCC Part 15 and Industry Canada licence-exempt RSS standard(s). Operation is subject to the following two conditions: (1) this device may not cause harmful interference, and (2) this device must accept any interference received, including interference that may cause undesired operation of the device.**

**Le présent appareil est conforme aux CNR d'Industrie Canada applicables aux appareils radio exempts de licence. L'exploitation est autorisée aux deux conditions suivantes : (1) l'appareil ne doit pas produire de brouillage, et (2) l'utilisateur de l'appareil doit accepter tout brouillage radioélectrique subi, même si le brouillage est susceptible d'en compromettre le fonctionnement.**

\* Abbreviated versions. See instructions that accompany Accessory or Vehicle owners manual for full details and instructions.

**SAVE THESE INSTRUCTIONS**

**READ AND FOLLOW ALL INSTRUCTIONS**

# Thank you for purchasing a Genie® brand garage door opener. The leader in garage door opener technology.

Please take a moment to preview this manual and assembly poster to ensure that you have the proper tools and general assembly and fabrication skills required to install a new garage door opener.

**Read and understand all Safety Warnings and Cautions contained in this manual before proceeding.**



***DO NOT RETURN PRODUCT TO STORE***  
***If you require assistance or have any questions, a knowledgeable Genie Service Technician is just a phone call away at:***  
***1-800-35-GENIE (1-800-354-3643)***  
***Or visit our website at:***  
***[www.geniecompany.com](http://www.geniecompany.com)***

Before setting up your new garage door opener, please note the model plate on the opener and serial number(s) located on the front of this manual. This information will be necessary should you seek technical support via our website, customer support department or local servicing Genie dealer.

Spanish language manuals available at: } [www.geniecompany.com](http://www.geniecompany.com)  
Idioma alternativo manuales disponibles en: }

# SAFETY NOTIFICATIONS & INSTRUCTIONS

## OVERVIEW OF POTENTIAL HAZARDS READ THIS SAFETY INFORMATION

Garage doors are large, heavy objects that move with the help of springs under high tension and electric motors. Since moving objects, springs under tension, and electric motors can cause injuries, your safety and the safety of others depend on you reading the information in this manual. If you have questions or do not understand the information presented, call your nearest trained door system technician or visit our website at [www.geniecompany.com](http://www.geniecompany.com).

### CONVENTIONS USED IN THESE INSTRUCTIONS

The following safety alert symbol and signal words are used throughout this manual to call attention to and identify different levels of hazards and special instructions.

This is the safety alert symbol. This symbol alerts you to potential hazards that can kill or hurt you and others. All safety messages will follow the safety alert symbol and the word "DANGER", "WARNING", or "CAUTION".



- **DANGER** indicates an imminently hazardous situation which, if NOT avoided, will result in death or serious injury.
- **WARNING** indicates a potentially hazardous situation which, if NOT avoided, could result in death or serious injury.
- **CAUTION** indicates a potentially hazardous situation which, if NOT avoided, may result in injury or property damage.
- The word **NOTE** is used to indicate important steps to be followed or important considerations.

Tous les messages concernant la sécurité seront indiqués après un symbole d'alerte de la sécurité et l'une des mentions suivantes "DANGER", "AVERTISSEMENT" ou "MISE EN GARDE".



- **DANGER** signale une situation dangereuse imminente qui, si elle n'est pas évitée, risque d'entraîner des blessures graves, voire mortelles.
- **AVERTISSEMENT** signale une situation potentiellement dangereuse qui, si elle n'est pas évitée, risque d'entraîner la mort ou des blessures graves.
- **MISE EN GARDE** signale une situation potentiellement dangereuse qui, si elle n'est pas évitée, risque d'entraîner des blessures ou des dommages matériels.
- Le terme **REMARQUE** est utilisé pour signaler les étapes importantes à suivre ou d'importants éléments à prendre en considération.

## IMPORTANT SAFETY INSTRUCTIONS

POTENTIAL HAZARD	EFFECT	PREVENTION
<p><b>MOVING DOOR</b></p>	<p><b>WARNING</b> Could result in Serious Injury or Death</p>	<p>Do Not operate unless the doorway is in sight and free of obstructions. Keep people clear of opening while door is moving. Do Not allow children to play with the door opener. Do Not change opener control to momentary contact unless an external reversing means is installed. Do Not operate a door that jams or one that has a broken spring.</p>
<p><b>ELECTRICAL SHOCK</b></p>	<p><b>WARNING</b> Could cause Serious Injury or Death</p>	<p>Turn off electrical power before removing opener cover. When replacing the cover, make sure wires are not pinched or near moving parts. Opener must be electrically grounded.</p>
<p><b>HIGH SPRING TENSION</b></p>	<p><b>WARNING</b> Could cause Serious Injury or Death</p>	<p>Do Not try to remove, repair or adjust springs or anything to which door spring parts are fastened such as wood block, steel brackets, cables or any other structure or like item. Repairs and adjustments must be made by a trained service representative using proper tools and instructions.</p>

## IMPORTANTES CONSIGNES DE SÉCURITÉ

DANGER POTENTIEL	EFFET	PRÉVENTION
<p><b>PORTE EN MOUVEMENT</b></p>	<p><b>AVERTISSEMENT</b> Pourrait entraîner des blessures graves voire la mort</p>	<p>Utiliser uniquement si la porte est en vue et libre de tout obstacle. Ne laisser personne se tenir dans l'ouverture de la porte pendant qu'elle est en mouvement. Ne pas permettre aux enfants de jouer avec l'opérateur de la porte. Ne pas modifier la commande de l'opérateur à contact momentané à moins qu'un moyen d'inversion externe soit installé. Ne pas faire fonctionner une porte qui bloque ou dont le ressort est cassé.</p>
<p><b>CHOC ÉLECTRIQUE</b></p>	<p><b>AVERTISSEMENT</b> Pourrait entraîner des blessures graves voire la mort</p>	<p>Couper le courant avant d'enlever le couvercle de l'opérateur. Lorsque le couvercle doit être remplacé, s'assurer que les fils ne sont ni coincés ni près des pièces mobiles. L'opérateur doit être correctement mis à la terre.</p>
<p><b>TENSION ÉLEVÉE RESSORT</b></p>	<p><b>AVERTISSEMENT</b> Pourrait entraîner des blessures graves voire la mort</p>	<p>Ne pas essayer d'enlever, réparer ni ajuster les ressorts ou toute autre pièce à laquelle le ressort de la porte est attaché, y compris blocs de bois, supports en acier, câbles ou autres articles semblables. Les réparations et les réglages doivent être effectués par technicien qualifié qui se sert d'outils appropriés et qui respecte les instructions.</p>

# IMPORTANT INSTALLATION INSTRUCTIONS



## WARNING

### TO REDUCE THE RISK OF SEVERE INJURY OR DEATH

READ AND FOLLOW ALL SAFETY, INSTALLATION AND OPERATION INSTRUCTIONS. If you have any questions or do not understand an instruction, call The Genie Company.

- **DO NOT** install opener on an improperly balanced door. An improperly balanced door could cause severe injury. Repairs and adjustments to cables, spring assembly and other hardware must be made by a trained service person using proper tools and instructions.
- Remove all ropes, and disable all locks connected to the door before installing opener.
- Where possible, install the door opener 7 feet or more above the floor. For products having an emergency release, mount the emergency release within reach, but at least 6 feet above the floor and avoiding contact with vehicles to avoid accidental release. **DO NOT** use emergency release cord to pull door.
- **DO NOT** connect the opener to the source of power until instructed to do so.
- Locate the wall control button: A) Within sight of door. B) At a minimum height of 5 feet, so small children cannot reach it. C) Away from all moving parts of the door.
- Install the entrapment WARNING label next to the wall button or console, in a prominent location. Install the emergency release handle on the emergency release cord.
- The opener must reverse when the door contacts a 1-1/2 inch high object on the floor at the center of the doorway. This is about the size of a 2" x 4" board laid flat.

# IMPORTANTES INSTRUCTIONS D'INSTALLATION



## AVERTISSEMENT

### POUR RÉDUIRE LES RISQUES DE BLESSURES GRAVES VOIRE MORTELLES

LIRE ET SUIVRE ATTENTIVEMENT TOUTES LES INSTRUCTIONS D'INSTALLATION ET DE FONCTIONNEMENT AINSI QUE TOUTES LES CONSIGNES DE SÉCURITÉ. Si vous avez des questions ou si vous ne comprenez pas une instruction, veuillez contacter directement The Genie Company.

- **NE PAS** installer l'opérateur sur une porte mal équilibrée. Celle-ci pourrait entraîner de graves blessures. Les réparations et les réglages des câbles, ensembles de ressort ou tout autre article de quincaillerie doivent être effectués par un professionnel qui se sert d'outils appropriés et qui respecte les instructions.
- Enlever toutes les cordes et désactiver toutes les verrous de la porte avant l'installer l'opérateur.
- Dans la mesure du possible, installer l'ouvre-porte à 2,1 m ou plus au-dessus du sol. Pour les produits dotés d'un cordon de déclenchement d'urgence, installer le déclenchement d'urgence mais au moins à 1,8 m au-dessus du sol en évitant tout contact avec les véhicules pour éviter qu'ils ne soient déclenchés accidentellement. **NE PAS** utiliser d'urgence cordon de libération pour ouvrir ou fermer la porte.
- **NE PAS** connecter l'opérateur à la source d'alimentation tant que l'instruction n'est pas donnée.
- Repérer la console murale: A) En vue de la porte. B) À une hauteur minimale de 1,5 m afin que les jeunes enfants ne puissent pas l'atteindre. C) Loin de toutes pièces mobiles de la porte du garage.
- Placer l'étiquette d'AVERTISSEMENT en cas de coinçage à proximité du bouton mural ou de la console de manière à ce qu'elle soit bien en évidence. Installer la poignée du cordon de déclenchement d'urgence.
- L'opérateur doit s'inverser lorsque la porte entre en contact avec un objet d'une hauteur de 3,8 cm placé sur le sol, au centre de l'ouverture de la porte. Ceci équivaut environ à une planche de 5 x 10 cm posée à plat sur le sol.



## WARNING

Opener is equipped with grounded electrical plug for your protection, and **only fits grounded electrical outlets. DO NOT** alter plug in any way! **If you have no grounded outlets, have one installed by a licensed electrician.** Opener must be properly grounded to prevent personal injury and equipment damage. **NEVER USE AN EXTENSION CORD!** Check local building codes for any requirement that you must have a permanent hard-wired connection. Permanent hard-wired connections must be performed by a licensed electrician using proper tools and instructions.



## AVERTISSEMENT

L'opérateur, qui est équipé d'une prise électrique mise à la terre pour votre protection **est compatible uniquement avec des prises électriques mises à la terre. NE PAS** modifier la fiche d'une quelconque manière. Si vous n'avez pas de prises mises à la terre, faites-en installer par un électricien agréé. L'opérateur doit être correctement mis à la terre pour éviter les blessures corporelles et des dommages matériels. **NE JAMAIS UTILISER DE RALLONGE!** Vérifiez les codes locaux des bâtiments pour connexions câblées permanente. Les connexions câblées permanentes doivent être effectuées par un électricien agréé qui se servira d'outils appropriés et respectera les consignes.

## 2 SAFETY & STANDARD FEATURES

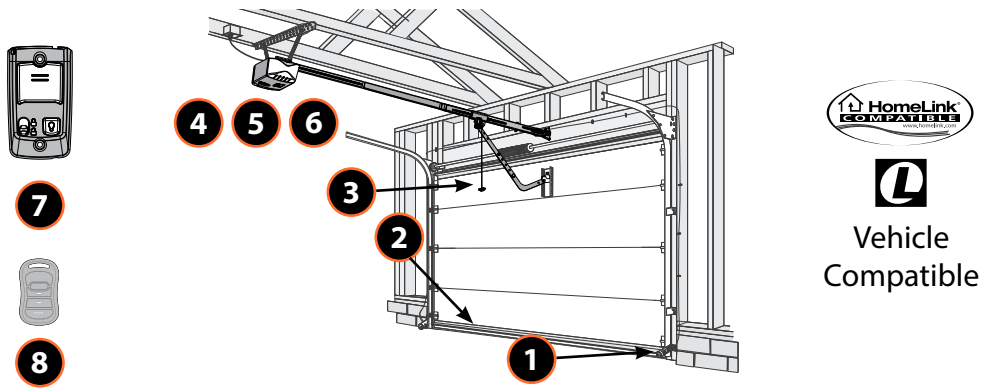

### 1. Safe-T-Beam® (STB) Non-Contact Reversing System:

- Places an infrared beam across the door opening.
- Only affects the DOWN travel of the door.
- Stops an open door from closing or reverses a door while in the down travel.
- Reversing system can be overridden with constant pressure on the wired wall console only.
- The door will stop and reverse to the full open position if beam is obstructed.
- Self-diagnostic LEDs on STBs and Powerhead alert to operational issues (See *Locating Safe-T-Beam® Pairs & Troubleshooting* section in this manual for more information).

### 2. Contact Reversing System:

- Automatically reverses a closing door upon contact with an obstruction (Force Control)

### 3. Manual Emergency Release pull handle & cord:

- Manually releases door from door opener. Used during a power failure or other emergency to allow manual opening and closing of the door.
- **DO NOT use emergency release cord to pull the door!**

### 4. Automatic Lighting System:

- Lighting system turns ON when door is activated and automatically turns OFF 4 minutes later.
- Can be activated/deactivated manually from the wall console.

### 5. Genie Battery Backup (BBU):

- Included or optional with select models. Provides power to opener in the event of a power failure. DO NOT install BBU until opener is fully installed, programmed and tested.

### 6. Integrated Aladdin Connect® (iDCM):

- Available with select models, allows operation of the garage door opener with a secure mobile device application (app) from anywhere.

### 7. Wall Console:

- Wired Wall Console included with select models. Operates door opener from inside garage with an open/close button. Has a light manual control and override. Sure-lock™ security activate switch to lock out all remote control operation.

### 8. Intellicode® Encryption, Factory Programmed Remote(s) :

- An encryption system that enhances the security of the door opener by continuously changing the access code each time the remote is used.
- Factory programmed remote control(s) included with this opener.

### 3 OPENER PROGRAMMING & ACCESSORY INSTALLATIONS

**NOTE:** Before programming the opener, check to make sure there are no objects in the garage door opening. DO NOT allow persons to enter the area of the door while programming and operating.

The following steps list the order of programming the opener's functional settings and install any accessories that were included with the opener or purchased separately. These steps should be performed in order.

1. Down Travel Limit
2. Up Travel Limit
3. Force Control
4. Contact Reverse test and adjustment
5. Remote Control Programming
  - Remote control(s) included with this opener are programmed at the factory. The information provided on this page should be used if adding additional remote controls.
6. Accessory Programming
  - Program wireless keypad (If applicable)
  - Program built in vehicle remote (If applicable)
  - Program wireless wall console (If applicable)
  - Program the Integrated Aladdin Connect (if applicable)
7. Install Battery Backup (If applicable)

#### Term Definitions:

**Travel Limits** Programmable setting to adjust how far door travels up or down.

**Force Control** refers to how much power is needed to move (open/close) a particular door and does NOT require programming.

**Remote & Accessory Programming** synchronizes remote devices with the powerhead. (Remote Controls, Wireless Keypad, Homelink®, Car-2-U® Systems)

**Speed Control** refers to how fast or slow the opener opens and closes the door. This is factory set and does NOT require programming. NOT available on all models.

#### Programming Button Layout

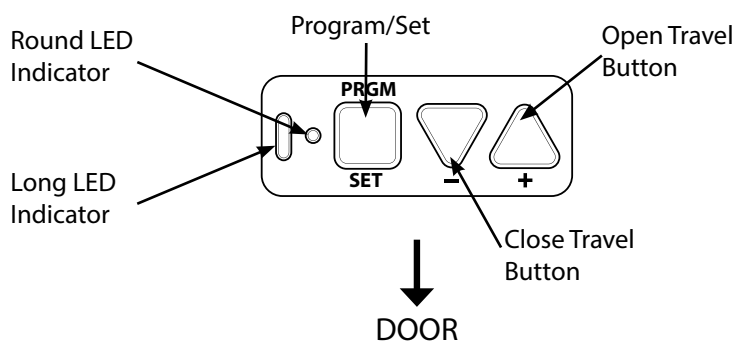

**NOTE:** Each programming step has a 30 second time limit for completion after the function is initiated. After 30 seconds, both LED's will illuminate RED indicating time has expired and the step must be restarted. Restart the step as many times as necessary to complete the programming.

# PROGRAMMING DOWN TRAVEL LIMIT

## ⚠ WARNING

- Make sure doorway is in full view and clear of obstacles and people to avoid injury or property damage.
- DO NOT operate this unit from the wall control before LIMITS are set. Severe damage to the opener could occur.
- The carriage MUST be engaged to turnbuckle BEFORE setting limits. See installation poster or call Customer Service at 1-800-35-GENIE or visit [www.geniecompany.com](http://www.geniecompany.com).
- DO NOT set limits with Battery Backup attached. AC power MUST be connected to the opener while setting limits for proper operation.

## ⚠ AVERTISSEMENT

- S'assurer que le passage de la porte est visible et dégagé, à savoir sans obstacles ni personne afin d'éviter toute blessure potentielle ou dommage matériel.
- NE PAS utiliser cette unité avec la console murale avant d'avoir réglé les LIMITES. L'ouvre-porte pourrait subir de sérieux dommages.
- La tendeur DOIT être engagée dans le chariot AVANT de régler les limites. Voir le poster d'installation (si fourni) ou appelez le service clientèle au 1-800-35-GENIE ou visitez le site [www.geniecompany.com](http://www.geniecompany.com).
- NE PAS fixer de limites en mode batterie de secours. L'alimentation CA DOIT être branchée sur l'ouvre-porte, pendant le réglage des limites, pour assurer un bon fonctionnement.

**⚠ NOTE:** Carriage should be locked to opener. Door should rest somewhere between full open and closed. Do not start with door fully open or closed.

### Programming DOWN Limit:

1. Press and hold the DOWN arrow button.
  - Long LED will light BLUE.
2. Release DOWN arrow button.
  - Long LED will flash BLUE.
3. Press and hold the DOWN arrow button until door is fully closed.
  - Use the UP arrow button if door closes too far. Use both UP and DOWN buttons to adjust close travel as necessary.

Door should rest on the floor until the weather strip is compressed enough to seal along the width of the door. Damaged doors or uneven floors may not seal properly. Repair these conditions to achieve a proper seal. DO NOT compress seal so much that the door will bend or buckle.

4. Press and release the SET/PRGM button.
  - Both LEDs will flash BLUE then go out.

The DOWN limit is now programmed.

### 1-2. Enter Programming Mode

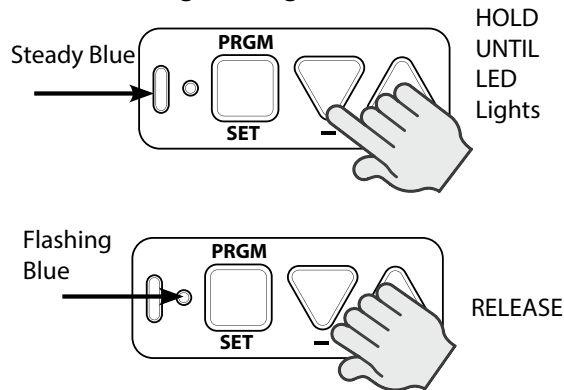

### 3. Adjust Door Position

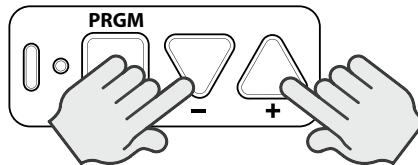

### 4. Lock Programming

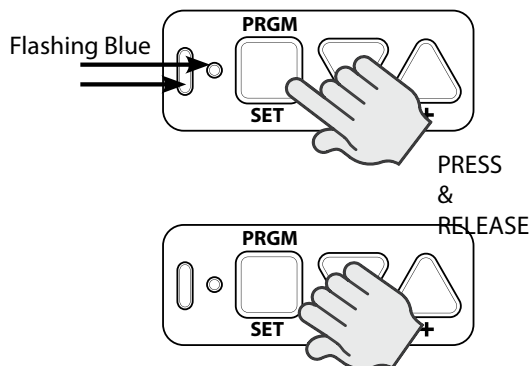



# PROGRAMMING UP TRAVEL LIMIT

## Programming UP Limit:

1. Press and hold the UP arrow button.
  - Long LED will light BLUE.
2. Release UP arrow button.
  - Round LED will flash BLUE.
3. Press and hold the UP arrow button until door is fully open.
  - Use the DOWN arrow button if door opens too far. Use both UP and DOWN buttons to adjust open travel as necessary.

## SECTIONAL DOOR UP LIMIT:

Door should fully open so that door seal is even with door header. Do not adjust so much that the door will bend, buckle or stretch door spring cables backward. Stop carriage short of the opener powerhead.

## ONE-PIECE DOOR UP LIMIT:

Door should fully open so that the door arms will be in line and push forward and up on the door.

**Door damage can result** if up limit is set too far back and door arms are angled downward pushing against the natural travel direction. Fig. A

Door should fully open so that door seal is even with door header. Do Not adjust so much that the door will bend or buckle or stretch door spring cables backward.

4. Press and release the SET/PRGM button
  - Both LEDs will flash BLUE then go out.

*The UP limit is now programmed.*

## One-Piece Door Limit Setting

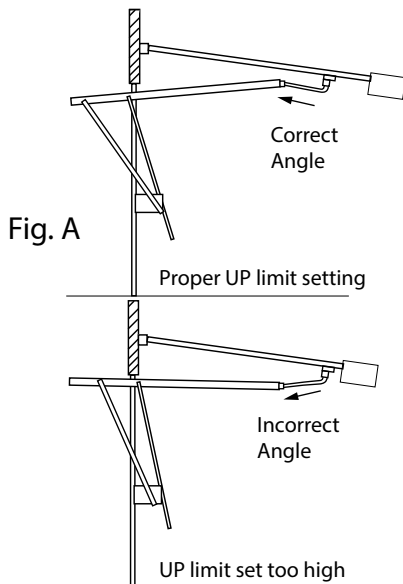

## 1-2. Enter Programming Mode

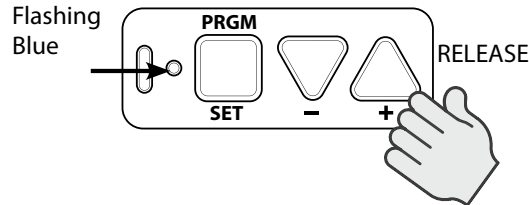
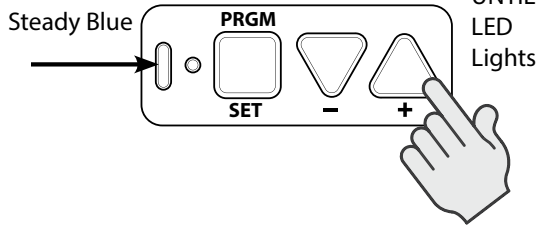

## 3. Adjust Door Position

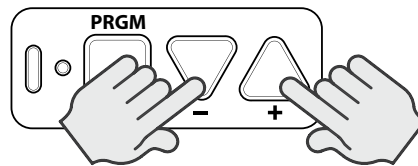

## 4. Lock Programming

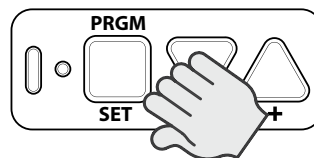
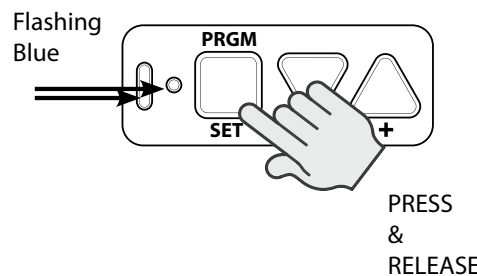

# PROGRAMMING FORCE AND CONTACT REVERSE

## Force Control

The force controls are automatically set when the wall control is used for the first time with garage door opener. The door **MUST** complete one full cycle, from full open to full close and then, full close to full open, before the settings are automatically recorded.

### ⚠ WARNING

#### TO AVOID INJURY OR DAMAGE

- **NEVER** adjust the force settings to adjust for damage, including an unbalanced door, binding door track or broken spring.
- Perform a CONTACT REVERSE TEST monthly.

### ⚠ AVERTISSEMENT

#### Pour éviter les blessures ou des dommages

- **NE JAMAIS** régler la force pour compenser des dommages, y compris une porte mal équilibrée, un rail de porte coincant ou des ressorts cassés.
- Tous les mois, EFFECTUEZ LE TEST D'INVERSION AU CONTACT.

1. Press and release the Wall Control button and allow the garage door to travel and stop at the DOWN limit.
2. Press and release the wall control button and allow the garage door to travel and stop at the UP limit.

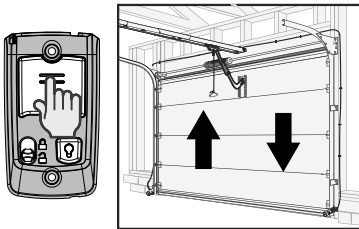

## Force Control Adjustments

Force settings are programmed from the factory to remain within safe parameters. These should not require adjustments. However, certain circumstances may require adjustment.

Refer to the "Maintenance and Adjustment" section, page 17, to adjust the force settings.

## Contact Reverse Test

**NOTE:** The limit and Force settings **MUST BE COMPLETED** before performing the Contact Reverse Test.

1. With the garage door open, lay a 2 X 4 board flat on the floor at the center of the door opening.
2. Close the garage door using the wall control.

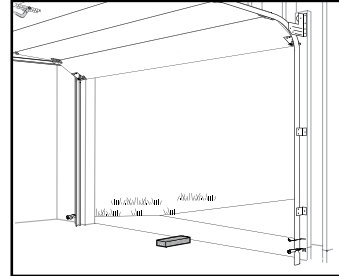
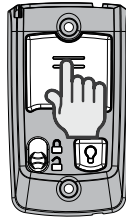

- When the door contacts the board, it should stop and reverse direction within 2 seconds to the full open position.
- The long LED light on the powerhead will begin to flash RED with the reversal of the door.
- Remove the 2" x 4" board and operate the opener with the wall control again. This cycle will clear the flashing red LEDs.

## Contact Reverse Adjustment

If the door stops before contacting the board or if it does not reverse direction to fully open after contact with the board, it may be due to an improperly set DOWN limit. Verify settings by:

1. Repeat the "Down Travel Limit" section to make certain the door is closing tight against the floor.
2. Repeat the "Force Control" section on the left to set force limits.
3. Repeat the "Contact Reverse Test" above.

Repeat this process as needed until the door passes the Contact Reverse Test.

Refer to the "Maintenance and Adjustment" section, page 17, to adjust the force settings.

# PROGRAMMING ADDITIONAL REMOTE CONTROLS

**THE REMOTE CONTROLS INCLUDED WITH THIS OPENER HAVE BEEN PROGRAMMED AT THE FACTORY FOR YOUR CONVENIENCE.**

**NOTE:** The following instructions are for remote control transmitters purchased separately in addition to those provided with this opener, but can also be used if any remote(s) may require re-programming.

**NOTE:** Each programming step has a 30 second time limit for completion after the function is initiated. After 30 seconds, two LED's will illuminate RED indicating time has expired and the step must be re-started. Restart the step as many times as necessary to complete the programming.

**NOTE:** Do not hold remote too close to the powerhead when programming remote buttons.

**NOTE:** Each button on each remote must be programmed separately, following these steps.

1. Remove the battery's protective film from the remote by pulling straight down.
2. Press and hold the SET/PRGM button on the opener for two seconds.
  - The ROUND LED will turn BLUE.
  - The LONG LED will then flash PURPLE.
3. Stand at least 5 feet away from opener and slowly press and release the desired button on the remote two times.
  - Both opener LEDs will flash and turn off indicating the remote has been programmed.
4. Press the desired remote button again.
  - The opener should run.

To program the same remote for other garage door opener, repeat the steps above using one of the other remaining remote buttons.

## REPEAT STEPS 1 TO 4 FOR EACH OPENER AND REMOTE

**NOTE:** It is possible to press the remote button too quickly or lightly. If the LEDs do not go off, press the remote button several more times to achieve confirmation.

**BASIC PROGRAMMING IS COMPLETE AND YOUR GARAGE DOOR OPENER IS READY TO USE.**

See page 18 of this manual to erase remote devices from memory.

## 1. Activate Remote



## 2. Enter Programming Mode

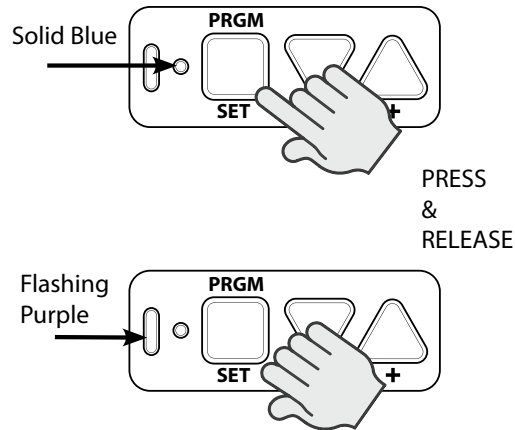

## 3. Press Remote Button Twice

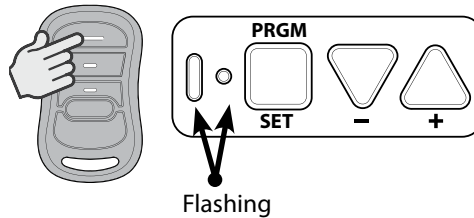

## 4. Test Remote

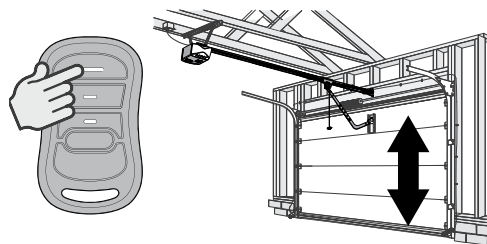

# PROGRAMMING ACCESSORIES (abbreviated)

## QuickView Single Door setup.

Please see complete instructions that accompany keypad

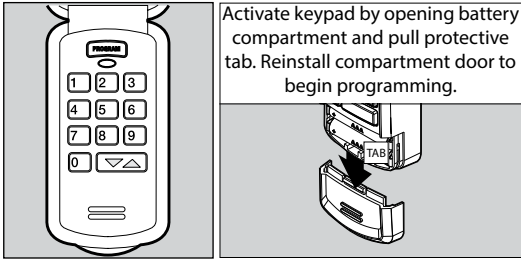

## Program Keypad before mounting.

### STEP 1) PROGRAMMING A PIN NUMBER (Single Door)

Program the keypad for the first time\* with a Personal Identification Number (PIN). This PIN must be 3 to 8 digits.

1. Ensure number pad back lighting is off.
2. Press 3-5-7 in sequence.
3. Press PROGRAM key. *LED will blink once per second.*
4. Enter a PIN number (3-8 digits).
5. Press PROGRAM key. *LED will blink twice and shut off.*

### STEP 2) PROGRAMMING THE KEYPAD TO 1 OPENER

1. Place garage door opener into PROGRAMMING MODE.
2. Ensure number pad back lighting is off.
3. Enter the PIN number on keypad.
4. Press the UP/DOWN key 3 to 4 times slowly until garage door opener operates.

### PUTTING OPENER INTO PROGRAMMING MODE:

1. Press and hold the program button on the powerhead until the round LED turns blue, then release.
2. The round LED will go out and the long LED will begin flashing purple.
3. Complete programming steps.



**NOTE:** The openers LEARN LED will time out in 30 seconds. Programming must be completed within 30 seconds.

### STEP 3) OPERATING THE KEYPAD WITH THE OPENER

#### Single Door Operation:

1. Ensure number pad back lighting is off.
2. Enter PIN number.
3. Press the UP/DOWN key.
4. Opener will operate.

**NOTE:** Keypad will remain active for 15 seconds after a successful entry is made. During this 15 seconds ANY key will operate the opener.

#### Resetting a PIN:

Press and hold both the **PROGRAM** key and the Up/Down key for about five seconds.

The LED's will slowly blink and then go out. When the LED stops blinking, the old programming has been successfully erased.

To create a new PIN, start with "Setting the PIN for the First Time"

### Mounting Keypad

The keypad **MUST** be mounted within sight of the garage door(s) at least five feet above the floor and clear of any moving door part.

1. Remove battery cover and batteries.

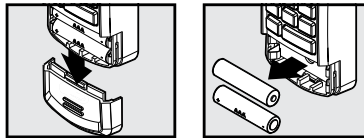

2. Drill 3/32" pilot hole for the top mounting screw (included).
3. Install a screw into the pilot hole, leaving a 1/8" gap between the screw head and wall.

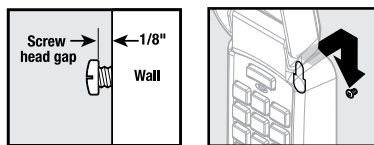

4. Hook the slotted mount, on back of keypad, over the screw.

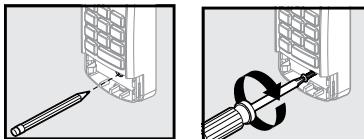

5. Mark and drill a pilot hole for the bottom screw (included) and secure keypad to wall (DO NOT overtighten).
6. Reinstall batteries and cover.

# PROGRAMMING VEHICLE SYSTEMS

## Programming HomeLink® System

### Step 1 Clear HomeLink

Clear HomeLink by pressing and holding down the first and third buttons until the indicator on the HomeLink blinks slow and then fast for 20 seconds; then release both buttons.

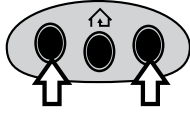

**NOTE:** Clearing the HomeLink will remove all previously programmed garage door openers.

### Step 2 Train HomeLink to the Remote

Choose the button on the HomeLink that will be used to open the door.

**NOTE:** Hold the Remote two inches from the HomeLink button.

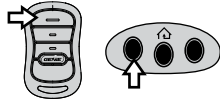

Hold down the remote button. While holding, press and hold the chosen HomeLink button.

Hold down both buttons until the indicator on the HomeLink blinks slow then fast. Once it blinks, release both buttons.

### Step 3 Program HomeLink to the Opener (Place opener into programming mode)

A. Press and hold the **PROGRAM** button on the opener until the round blue LED is ON. Release the button. The long purple LED will begin flashing.

#### PUTTING OPENER INTO PROGRAMMING MODE:

1. Press and hold the program button on the powerhead until the round LED turns blue, then release.
2. The round LED will go out and the long LED will begin flashing purple.
3. Complete programming steps.



**NOTE:** The openers LEARN LED will time out in 30 seconds. Programming must be completed within 30 seconds.

B. Press the chosen HomeLink button for two seconds and release. Press that same button again for two seconds and release. The long LED will flash blue and then turn off.

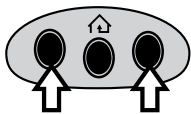

C. Press the HomeLink button a few more times until door moves.

**NOTE:** For additional instructions, see the motor vehicle manual, [www.homelink.com](http://www.homelink.com) or visit [www.geniecompany.com](http://www.geniecompany.com)

## Programming Car2U® System

### Step 1 Clear Car2U to default settings

The default setting for the Car2U system is:

- Button 1 = Genie® Manufactured Openers
- Button 2 = LiftMaster® Manufactured Openers
- Button 3 = Wayne Dalton® Manufactured Openers

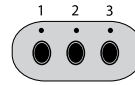

- A. Press and hold buttons 1 and 3 for 20 seconds or until all three LEDs begin to flash.
- B. Release both buttons. The Car2U system is now set to the Factory Default settings

**NOTE:** Clearing the Car2U remote will remove all previously programmed garage door openers.

### Step 2 Program Car2U to the Genie® Opener (Place opener into programming mode)

- A. Press and hold the **PROGRAM** button on the opener until the round blue LED is ON—release the button. The long purple LED will begin flashing.
- B. Press the designated Car2U button for two seconds and release. Press that same button again for two seconds and release. The long LED will flash blue and then turn off.
- C. Press the Car2U button a few times more until door moves.

#### PUTTING OPENER INTO PROGRAMMING MODE:

1. Press and hold the program button on the powerhead until the round LED turns blue, then release.
2. The round LED will go out and the long LED will begin flashing purple.
3. Complete programming steps.



**NOTE:** The openers LEARN LED will time out in 30 seconds. Programming must be completed within 30 seconds.

### Step 3 Changing Factory Default Button for a Genie® Opener

- A. Press and hold buttons 1 & 3 for **ONE SECOND** and release—all three LEDs will light solid red.
- B. Press and hold the button (2 or 3) to change it to—the corresponding LED will flash. While continuing to hold that button, press and release button 1. Press and release button 1 again.
- C. Release the button being held in step B and wait for the LED to stop flashing. This button is now set.  
Repeat Step 2 for second Opener.

**NOTE:** For additional instructions see the motor vehicle manual, [learcar2u.com](http://learcar2u.com).

# PROGRAMMING TO USE ALADDIN CONNECT®

Perform these steps only after opener is fully installed, programmed and tested.

## IMPORTANT SAFETY INSTRUCTIONS

### WARNING

TO REDUCE THE RISK OF SEVERE INJURY OR DEATH, READ AND FOLLOW ALL INSTRUCTIONS.

1. Never allow children to operate or play with door controls.
2. Install the entrapment WARNING placard next to the wall control in a prominent location.
3. NO PERSONS SHOULD CROSS THE PATH OF A MOVING DOOR.
4. NEVER GO UNDER A STOPPED/PARTIALLY OPEN DOOR.
5. The Aladdin Connect® operating system is designed for unattended operation. The door could move unexpectedly.

**SAVE THESE INSTRUCTIONS**

## CONSIGNES DE SÉCURITÉ IMPORTANTES

### AVERTISSEMENT

POUR RÉDUIRE LE RISQUE DE BLESSURES GRAVES VOIRE MORTELLES, LIRE ET COMPRENDRE TOUTES LES INSTRUCTIONS.

1. NE JAMAIS laisser les enfants utiliser ou jouer avec les commandes de l'ouvre-porte.
2. Placer l'étiquette d'AVERTISSEMENT en cas de coincage à proximité du bouton mural ou de la console murale de manière à ce qu'elle soit bien en évidence.
3. NE JAMAIS PASSER SOUS LA PORTE EN MOUVEMENT.
4. NE JAMAIS PASSER SOUS UNE PORTE À L'ARRÊT PARTIELLEMENT OUVERTE.
5. Le système d'exploitation Aladdin Connect™ a été conçu pour fonctionner sans surveillance. La porte peut se déplacer de façon inattendue.

**CONSERVER CES INSTRUCTIONS**

## Genie® Integrated Aladdin Connect® Models

The Aladdin Connect® system is a convenient mobile device app to operate up to 20 garage door openers/controllers from anywhere.

The Aladdin Connect® app has the following features:

- Up to 20 users for each account.
- Sends notifications any time the garage door is operated from the app, wall console or remote control.
- Show reports for opener usage showing dates and times when the opener was operated.
- Show reports of who operated the opener when used from another user on the account.
- Set custom RULES for predetermined times to automatically close a chosen door and/or notify of its operation.
- Opener light system and an audible signal will activate as a warning that the opener is about to operate.



To use the Genie Aladdin Connect® app to control this garage door system follow these steps.

***Other home automation apps may also control this garage door opener system. Check our website at [www.geniecompany.com](http://www.geniecompany.com) for updates pertaining to compatible 3rd party apps.***

### 1 Check Wi-Fi Signal

***FOR ALL APPS - Use smart phone or other mobile device to check Wi-Fi signal strength.***

Hold the device near the garage door opener and check Wi-Fi meter on the device.

If signal is present, proceed to step 2 if using the Aladdin Connect® app.

***Follow manufacturers instructions for other 3rd party apps.***

If signal is very weak or nonexistent, try the following:

- Move Wi-Fi router closer to the garage.
- Install a Wi-Fi range extender.  
(Available at most electronics stores.)



## 2 Download the Aladdin Connect® app (Unless using 3rd party app)

**Scan for iOS app**  
Versions 8 and higher



Apple and the Apple logo are trademarks of Apple Inc., registered in the U.S. and other countries. App Store is a service mark of Apple Inc.

**Scan for Android app**  
Versions 4.4 and higher



## 3 Follow the Aladdin Connect® app instructions

Follow steps per the app instructions.

- Create an account
- Set up opener(s)
- Add users
- Set rules and notifications.

For help at any time contact The Genie Company at 1-866-599-4995 or visit our website.  
[www.geniecompany.com/aladdinconnect](http://www.geniecompany.com/aladdinconnect)



Scan the Aladdin Connect® QR Code on the front of this manual or on the powerhead when prompted by the Aladdin Connect® app.

## 4 Install WARNING placard

Place included unintended operation warning placard next to garage door openers wall button.

**NOTE:** This placard should be used in lieu of the standard WARNING placard included with this opener.

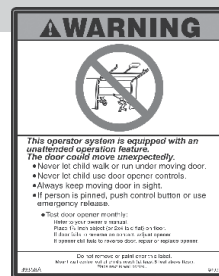

**NOTE:** Use of this product, the software embedded within this product and the related application software is subject to the Terms and Conditions available at:  
[www.geniecompany.com/aladdinconnect](http://www.geniecompany.com/aladdinconnect)

## IMPORTANT SAFETY INSTRUCTIONS

### ⚠️ WARNING

**To reduce the risk of severe injury or death, read and follow all instructions.**

1. **NEVER** let children operate or play with the door controls.
2. Keep remote away from children.
3. **ALWAYS** keep the moving door in sight and away from people and objects until door is completely closed. NO ONE SHOULD CROSS THE PATH OF THE MOVING DOOR.
4. **NEVER** GO UNDER A STOPPED, PARTIALLY OPEN DOOR.
5. Test opener monthly. The door **MUST** reverse on contact with a 1-1/2" high object (or 2" x 4" board laid flat) at the center of the doorway on the floor. After adjusting either the force or limit of travel, retest door opener. Failure to adjust the opener properly may cause severe injury or death.
6. When possible, use emergency release only when door is closed. Use caution when using this release with the door open. Weak or broken springs are capable of increasing the rate of door closing and increasing the risk of severe injury or death.
7. **KEEP DOORS PROPERLY BALANCED.** See your garage door Owner's Manual. An improperly balanced door increases the risk of severe injury or death. Have a trained door system technician make repairs to cables, spring assemblies, and other hardware.

### SAVE THESE INSTRUCTIONS

## IMPORTANTES CONSIGNES DE SÉCURITÉ

### ⚠️ AVERTISSEMENT

**Pour réduire le risque de blessures graves voire mortelles, lire et comprendre toutes les instructions.**

1. **NE JAMAIS** permettre aux enfants d'actionner ou de jouer avec les commandes de la porte.
2. Tenir les télécommandes hors de la portée des enfants.
3. **TOUJOURS** garder en vue la porte en mouvement et tenir à l'écart toute personne ou objet jusqu'à ce que la porte soit totalement fermée. PERSONNE NE DOIT TRAVERSER LA TRAJECTOIRE D'UNE PORTE EN MOUVEMENT.
4. **NE JAMAIS** PASSER SOUS UNE PORTE À L'ARRÊT PARTIELLEMENT OUVERTE.
5. Tester l'ouvre-porte une fois par mois. La porte de garage **DOIT** inverser sa course au contact d'un objet de 4 cm (planche de 5 sur 10 cm) posé à plat sur le sol au centre de l'ouverture de la porte. Après avoir réglé la force ou la limite de la course, retenter l'ouvre-porte de garage. Un mauvais réglage de l'ouvre-porte peut entraîner des blessures graves voire mortelles.
6. Utiliser, dans la mesure du possible le déclenchement d'urgence uniquement lorsque la porte est fermée. Utiliser le déclenchement d'urgence avec prudence lorsque la porte est ouverte. Des ressorts faibles ou brisés peuvent faire descendre la porte rapidement ce qui peut entraîner des blessures graves voire mortelles.
7. **VEILLER À CE QUE LA PORTE SOIT CORRECTEMENT ÉQUILIBRÉE.** Consulter le manuel du propriétaire de la porte de garage. Une porte déséquilibrée pourrait entraîner de graves blessures voire mortelles. Demander à un technicien spécialisé en système de portes de se charger des réparations des câbles, des ressorts et de toute autre quincaillerie.

### CONSERVER CES INSTRUCTIONS

#### ⚠️ WARNING

Use of any other wall control can cause unexpected operation of the door and loss of lighting feature. Locate wall console within sight of the door but far enough from door to prevent contacting it while operating the console. Control must be at least 5 feet above the floor to prevent small children from operating it.

#### ⚠️ AVERTISSEMENT

L'utilisation d'une autre commande murale pourrait produire des résultats inattendus de la porte ainsi que le dysfonctionnement de l'éclairage. Localisez la console murale en vue de la porte et suffisamment loin de la porte pour éviter tout contact pendant l'utilisation de la console. La commande doit être à une hauteur minimale de 1,5 m au-dessus du sol afin que les jeunes enfants ne puissent pas l'atteindre.



**Regular inspection/maintenance for the door and opener should be performed at regular intervals to ensure the system runs at peak safety, performance and efficiency.**

MAINTENANCE ITEM	INTERVALS	DETAILS
Contact Reverse Test	Monthly	See Page 8 to run system test.
Lubricate Door Hardware	Monthly	Lubricate Rollers & Hinges with a light weight general purpose grease.
Safe-T-Beam® system check	Monthly	Check wiring for loose connections, cracks or worn insulation. Clean lenses of dirt & debris.
Door Balance	Monthly	See Maintenance Detail <b>A</b>
Battery Backup System	Monthly	Unplug opener from outlet. Test opener with remote or wall console. Replace battery if needed.
Lubricate Screw drive	Yearly	Use Genie Lube™ to keep screw drive rail operating smoothly.
Remote Battery replacement	As Needed	See Maintenance Detail <b>B</b>
Light Bulb Replacement	As Needed	See Maintenance Detail <b>C</b>

## A Door Inspection

**Perform the Door inspection as follows:**

With the door closed, pull manual emergency release handle DOWN and away from door and let go to disengage the carriage from the drive chain or belt. FIG.1.

- Raise and lower the door manually. Door should move freely and smoothly.
  - Raise door manually about 3' to 4' feet from floor and let go.. Door should remain stationary or slowly drift closed. FIG. 2.
- If door opens or closes rapidly, **CONTACT A TRAINED DOOR SYSTEM TECHNICIAN** to have your door springs serviced.
- Close the door.
  - Place the carriage in the "engage" position Reverse of FIG. 1.
  - Operate door using remote or wall control. The carriage will reattach itself to the drive chain/belt.

**! WARNING**

- Garage door hardware (springs, cables, brackets, pulleys, etc.) are under extreme pressure and tension.
- **DO NOT** attempt to repair or adjust door springs or any hardware, and **DO NOT OPERATE** garage door automatically or manually if door is improperly balanced or springs are broken.
- **CONTACT A TRAINED DOOR SYSTEM TECHNICIAN.**

**! AVERTISSEMENT**

- La quincaillerie de la porte de garage (ressorts, câbles, supports, poulies, etc.) sont sous des pressions et des tensions extrêmes.
- **NE PAS** réparer ni régler les ressorts de la porte ou toute autre pièce de quincaillerie et **NE PAS ACTIONNER** la porte manuellement ou automatiquement si elle n'est pas correctement équilibrée ou si des ressorts sont cassés.
- **CONTACTEZ UN TECHNICIEN SPÉCIALISÉ EN SYSTÈME DE PORTES**

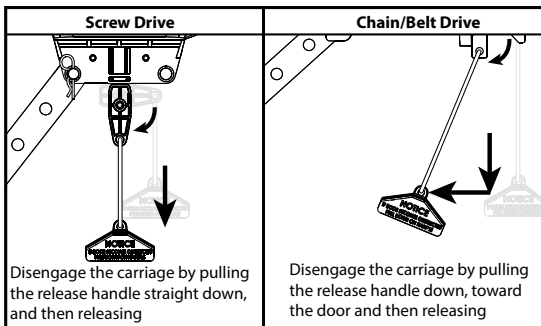

**DO NOT** use release cord to pull door!

FIG.1



FIG 2

## B Replacing Batteries

### Remote Battery Replacement (1-button)

Replace remote battery with a CR2032 coin cell battery.

1. Slide the battery cover off.
2. Slide out the old battery and slide in the new. Be sure positive side (+) is UP.
3. Slide the battery cover on until it snaps into place.

### Remote Battery Replacement (3-button)

Replace remote battery with a CR2032 coin cell battery.

1. Open remote case using a washer or coin that fits into the slot on the top of the remote.
2. Replace battery. Be sure positive side (+) is UP.
3. Align components and snap case closed.

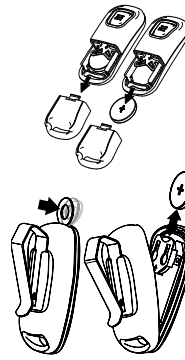

## C Changing Light Bulbs (Genie LED bulbs recommended)

### ⚠ WARNING

- Use extreme caution when working from a ladder or step stool or serious injury can occur.
- When replacing light cover, make sure wires are not pinched or near moving parts.
- Use only properly rated incandescent, LED or CFL light bulbs.
- DO NOT use bulbs with a rating greater than 60 Watts.
- Use A19 size light bulbs. DO NOT use bulbs having a short neck.

### ⚠ AVERTISSEMENT

- Faire particulièrement attention lors de travaux effectués depuis une échelle ou en escabeau.
- En referment le couvercle de l'éclairage, s'assurer que les fils ne sont ni coincés ni près des pièces mobiles.
- Utilisez uniquement incandescence correctement classé, LED ou des ampoules fluocompactes.
- NE PAS utiliser des ampoules avec une note supérieure à 60 Watts
- Utilisez A19 ampoules de taille. NE PAS utiliser des ampoules ayant un cou court.

1. Disconnect power to opener.
  2. Open powerhead lens cover by pressing in on upper locking tab and lower cover.
  3. Replace old light bulbs with 60 Watt MAXIMUM incandescent, CFL or LED equivalent\*\*.
- \* Genie LED light bulbs, which are specifically made for garage door openers, are recommended.
4. Close lens cover.
  5. Reconnect power to door opener.
  6. Test light operation.

**NOTE:** Use of standard LED bulbs may reduce the range of your remote controls\*.

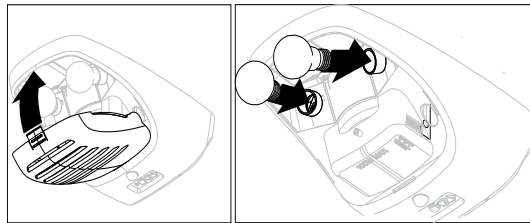

**\* Genie LED light bulbs are designed to reduce or eliminate reduced remote range issues caused by common LED bulbs. They also offer better product life by making them resistant to vibration caused by the opener, and cold or damp weather. See website for details at [www.geniecompany.com](http://www.geniecompany.com). recommendations for LED bulbs.**



Models equipped with Integrated LED lighting require specialty kits available for order in the parts section. See page 24.

**\*\*Integrated Aladdin Connect® models require a MINIMUM 40 Watt or equivalent bulb, 100 watt maximum.**

# 5 SPECIAL INSTALLATION INFORMATION

## Changing Force Settings

### ⚠ WARNING

#### TO AVOID INJURY OR DAMAGE

- **NEVER** adjust the force settings to adjust for damage, including an unbalanced door, binding door track or broken spring.
- Perform a CONTACT REVERSE TEST monthly.

### ⚠ AVERTISSEMENT

#### Pour éviter les blessures ou des dommages

- **NE JAMAIS** régler la force pour compenser des dommages, y compris une porte mal équilibrée, un rail de porte coincant ou des ressorts cassés.
- Tous les mois, EFFECTUEZ LE TEST D'INVERSION AU CONTACT.

### Force Settings:

Force settings are pre-programmed at the factory and applied during the Open/Closed Limit settings steps. For normal use, these settings should not need adjustment.

### Conditions possibly requiring adjustments are:

1. Doors with very stiff weather seals.
2. Doors that start down, STOP, and reverse before closing.
3. Doors that start up, but STOP before they completely open.

1. **Press and hold** both UP & DOWN arrow buttons until the ROUND LED turns RED. Release buttons.

- LEDs will show current force level. SEE CHART.
2. Press either the UP or DOWN arrow button until the desired UP force setting is shown. SEE CHART.
  3. Press & release the PRGM button to lock the desired UP FORCE setting.
    - LEDs will now show the current DOWN FORCE setting. SEE CHART.
  4. Press either the UP or DOWN arrow button until desired DOWN force setting is shown. SEE CHART.
  5. Press & release the PRGM button to lock the desired DOWN FORCE setting.
    - Both LEDs will turn BLUE then go out confirming that the force settings have been changed and are locked.
  6. Opener is now ready to operate and test.
  7. Operate door from the wall console two full cycles then perform safety contact reverse test. (SEE PAGE 8)

PRESS & RELEASE

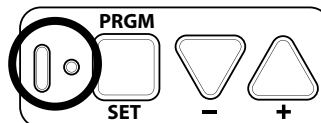
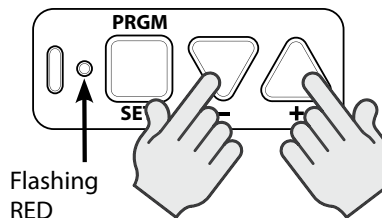

See Chart for Force level indicators.

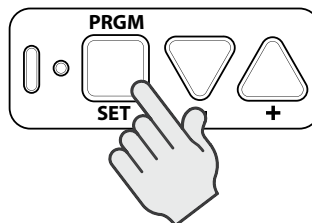

Press PRGM to lock settings

FORCE SETTING CHART		
Force Level	Long LED	Round LED
1 (LOWEST)	OFF	BLUE
2	BLUE	OFF
3	BLUE	BLUE
4	OFF	VIOLET
5	VIOLET	OFF
6	VIOLET	VIOLET
7	OFF	RED
8	RED	OFF
9 (HIGHEST)	RED	RED

## CLEARING MEMORY OF ACCESSORIES

**NOTE:** Clearing memory of remotes from the powerhead will clear ALL programmed remotes, wireless keypads and vehicle transmitters. The opener will no longer recognize any signal from any remote device, including a missing remote device. This does not include the Aladdin Connect® or Wireless Wall Console.

All remaining (or recovered) remotes, vehicles and wireless keypads MUST be reprogrammed.

**NOTE:** The garage door opener will operate normally using the wall console.

1. Press and hold the SET/PRGM button on the opener for two seconds.
  - The ROUND LED will turn BLUE.
  - The ROUND LED will then flash PURPLE.
2. Press and hold the UP & DOWN buttons at the same time until both LEDs turn off.
  - Both opener LEDs will flash and turn off indicating that all remotes have been erased.
3. Press any remote button.
  - The opener should NOT run.

To deprogram the same remote for other garage door openers, repeat the steps above using one of the other remaining remote buttons.

### 1. Enter Programming Mode

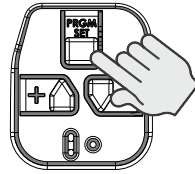

Solid Blue

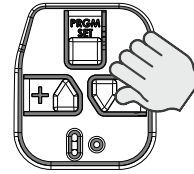

Flashing Purple

### 2. Press and Hold + & - Buttons

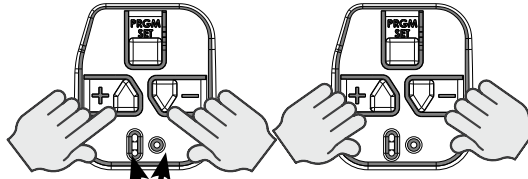

Flashing Blue

Release when LEDs turn off

### 3. Test Remote

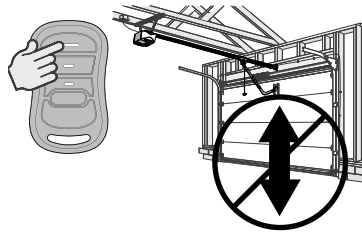

## USE OF DONGLE PORTS - Network & BBU

**NOTE:** Dongle ports are used for installing the battery backup (BBU) and Close Confirm® remote controls.

Fully read and understand instructions included with these accessories prior to installation and use.

**Accessories available at your local supplier of Genie® products.**

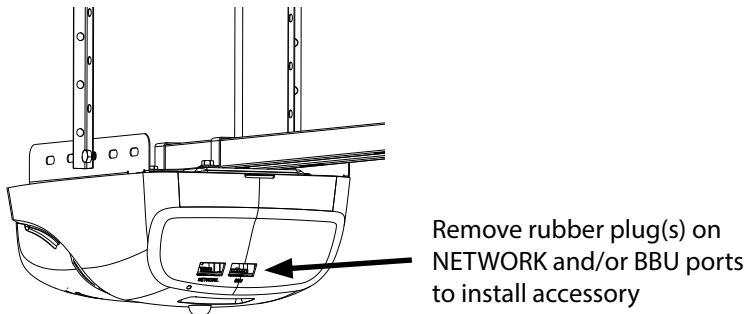

Closed Confirm™ Remote Network Adapter

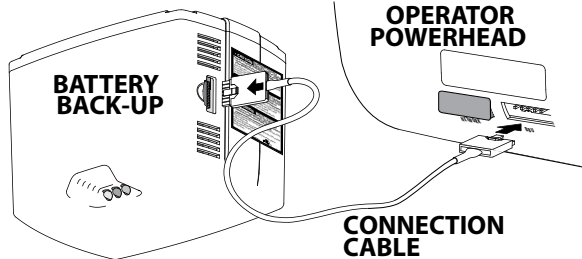
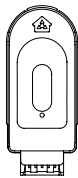
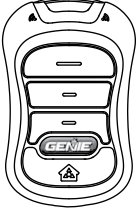

# Installing Safe-T-Beams® on multiple garage doors (Preventing “cross-talk”)

LOCATING SAFE-T-BEAM® PAIRS  
Transmitter (RED LED) and Receiver (GREEN LED)

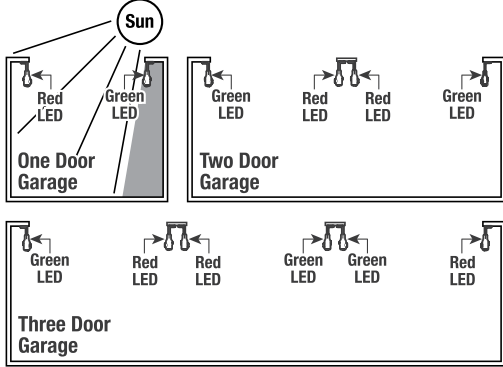

## Single Garage Door

- Determine which side of the garage receives direct sunlight.
- Position the Transmitter (Red LED) on the direct sunlight side.

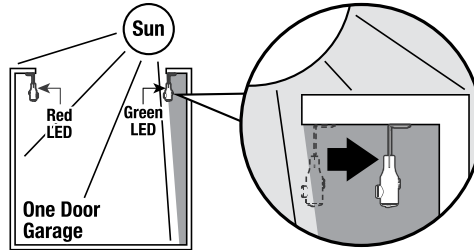

**NOTE:** Only use Safe-T-Beams® that are included with this opener. **DO NOT** use other brands or types of photocells on this opener.

## Adjusting Speed Control

### Speed Settings (DC Models only)

Speed settings are pre-programmed at the factory for the maximum speed. Speed settings should not need adjustment with this unit. However, travel speed for the opener can be adjusted to a slower speed in both the Open and Close directions, to minimize wear on heavier sectional doors. There are three speed settings available for sectional doors. Please note that speed may be affected by door weight and balance, along with condition of door components and tracks.

### TO CHANGE OPENER TRAVEL SPEED:

1. Press and Hold the PRGM button until both LEDs turn BLUE, then release.
  2. Press the UP button twice.
  3. Press PRGM button once.
- The current UP speed setting will now be displayed. (SEE CHART).
4. Press either UP or DOWN buttons to adjust speed (SEE CHART)
  5. Press PGRM button once to lock in the UP travel speed.
- The current DOWN speed setting will now be displayed. (SEE CHART).
6. Press either UP or DOWN buttons to adjust Down Travel Speed (SEE CHART).
  7. Press PGRM button once to lock in the DOWN travel speed.

Opener is now ready to operate and test.

Operate door from the wall console two full cycles then perform safety contact reverse test. (SEE PAGE 8)

SPEED SETTING CHART		
Speed Level	Long LED	Round LED
HIGH	RED	RED
MED	PURPLE	PURPLE
LOW	BLUE	BLUE

## Multiple Garage Doors

- NEVER position Safe-T-Beam® modules where signals will cross.
- Place the Transmitter (Red LED) Safe-T-Beams on adjacent doors facing in opposite directions.

**NOTE:** Direct sunlight creates interference with Safe-T-Beam® Receiver (Green LED). STB modules CAN be positioned further away from the door opening if necessary to avoid sunlight but no further off the wall to maintain alignment with the Transmitter (Red LED) module.

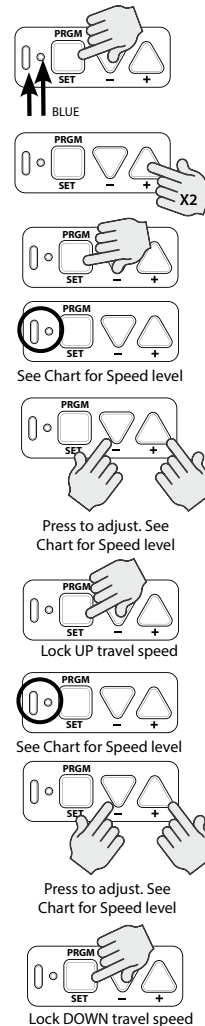

# 6 TROUBLESHOOTING

Use the guide below along with the self diagnostic powerhead LEDs to help troubleshoot any problems.



**Need help or have questions? DO NOT RETURN to the store.**  
 Visit [www.geniecompany.com](http://www.geniecompany.com) or call Customer Service at 1-800-35-GENIE.

PROBLEM:	WHAT TO DO:
<b>Opener does NOT operate when wall control is pressed.</b>	<ul style="list-style-type: none"> <li>• Turn Sure-Lock™ OFF See page 4.</li> <li>• Check power source.                             <ul style="list-style-type: none"> <li>– Plug a lamp into outlet used for powerhead. If lamp works, power source is OK.</li> <li>– If not, check fuse or circuit breaker.</li> </ul> </li> <li>• If power is OK,                             <ul style="list-style-type: none"> <li>– Check connections at powerhead terminals and at wall console.</li> </ul> </li> <li>• Check for reversed, broken or cut wires. Staples can cut insulation and short wires. Repair or replace.</li> </ul>
<b>Opener runs, but door does not move.</b>	<ul style="list-style-type: none"> <li>• Make sure carriage is engaged with chain/belt/screw. Refer to installation poster or download poster from <a href="http://www.geniecompany.com">www.geniecompany.com</a></li> <li>• Check to make sure chain/belt is not broken or off its pulley.</li> </ul>
<b>Opener works from wall control, but NOT from remote.</b>	<ul style="list-style-type: none"> <li>• Check all remotes.</li> <li>• Replace remote battery. See page 16.</li> <li>• Program remotes to powerhead. See page 9.</li> </ul>
<b>Remote has less than 25 feet operating range or no operation.</b>	<ul style="list-style-type: none"> <li>• Relocate remote inside car and /or point remote at garage door.</li> <li>• Replace battery. See page 16.</li> <li>• Reposition door opener antenna.</li> <li>• Eliminate possible competing signals (radio, etc.).</li> <li>• LED bulbs may be interfering with remote signal. See page 16.</li> </ul>
<b>Door starts down, then STOPS and goes back up. OR Safe-T-Beam® System malfunction.</b>	<ul style="list-style-type: none"> <li>• If a NEW installation, check Door Arm position. Refer to Installation poster or download poster from <a href="http://www.geniecompany.com">www.geniecompany.com</a>.</li> <li>• If NEW Installation, make sure ONLY the Safe-T-Beams® that came with this opener are installed.</li> <li>• Check if limits are properly set. See pages 6-7. Adjust limits as needed.</li> <li>• Check if Safe-T-Beam® red LED is flashing. See page 19, Safe-T-Beam® system check.</li> <li>• Check Safe-T-Beam® system for beam obstruction or misalignment of lenses. See page 19, Safe-T-Beam® system.</li> <li>• Check garage door for binding.</li> <li>• If an operational problem exists, and opener will not close, the opener can be forced to close as follows: Press and hold the wall control button until door is completely closed.</li> <li>• Check for interference from adjacent Safe-T-Beam® units. See page 19.</li> <li>• Contact Genie at 1-800-35-GENIE.</li> </ul>
<b>Door starts down, then STOPS before it is closed. OR Door will only open.</b>	<ul style="list-style-type: none"> <li>• Check Safe-T-Beam® wire connection at powerhead and at STBs. See page 19, Safe-T-Beam® system check.</li> <li>• Check if limits are properly set. See pages 6-7. Adjust limits as needed.</li> <li>• Check CONTACT REVERSE. See page 8.</li> <li>• Check garage door for binding. See maintenance and adjustment. Page 15.</li> <li>• Check closing "FORCE" control. See page 8, or Force settings. Page 17.</li> </ul>
<b>Door starts up, but STOPS before it is completely open.</b>	<ul style="list-style-type: none"> <li>• Check if limits are properly set. See pages 6-7. Adjust limits as needed.</li> <li>• Be sure door, opener, springs are in good repair, properly lubricated and balanced. Page 15.</li> <li>• Check closing/opening "FORCE" control. See page 8, or Force settings Page 17.</li> <li>• If you suspect a problem with the garage door hardware or springs, visit <a href="http://www.geniecompany.com">www.geniecompany.com</a> and use the "dealer locator" to hire a local door service professional.  <b>NEVER try to repair door hardware or springs yourself.</b></li> </ul>
<b>Door will only run closed.</b>	<ul style="list-style-type: none"> <li>• Turn Sure-Lock™ OFF See page 4.</li> <li>• Check if limits are properly set. See pages 6-7.</li> <li>• Check door balance, condition, and door spring. Page 15.</li> <li>• Check opening "FORCE" control. See page 8, or Force settings. Page 17.</li> <li>• If you suspect a problem with the garage door hardware or springs, visit <a href="http://www.geniecompany.com">www.geniecompany.com</a> and use the "dealer locator" to hire a local door service professional.  <b>NEVER try to repair door hardware or springs yourself.</b></li> </ul>
<b>Door opener starts for no reason.</b>	<ul style="list-style-type: none"> <li>• Button stuck on wall control or remote.</li> <li>• Was remote lost or stolen? Erase all remotes from powerhead memory and program new remotes. See page 18.</li> </ul>
<b>Noisy operation.</b>	<ul style="list-style-type: none"> <li>• Be sure all door fasteners are tight. Page 15</li> <li>• Be sure garage door is in good repair, properly lubricated and balanced. Page 15</li> <li>• Be sure opener is in good repair.</li> </ul>
<b>Door opener runs slow.</b>	<ul style="list-style-type: none"> <li>• Check operating condition of door. Door may need professional repair/adjustment.</li> </ul>

# TROUBLESHOOTING

## POWERHEAD LEDS

Powerhead LED		Possible Problem	Solution
Round LED	Long LED		
OFF	OFF	Normal operation.	None required.
		No response from unit.	Check power supply. Contact a trained door system professional.
ON/RED/ STEADY	ON/RED/ STEADY	Limits NOT set properly.	Re-program limits, see pages 6-7.
ON/RED/ FLASHING	ON/RED/ FLASHING	Program error.	Unplug unit, wait 5 seconds, plug in.
		Component failure.	Contact a trained door system technician.
ON/BLUE/ FLASHING	OFF	Remote NOT programmed.	Program remote, see page 9.
ON/PURPLE/ FLASHING	OFF	Remote NOT programmed.	Program remote, see page 9.
ON/RED/ FLASHING	OFF	Safe-T-Beam® physical obstruction.	Remote obstruction, recheck unit.
		Safe-T-Beam® signal interference.	Check alignment of Safe-T-Beam® pair and nearest other Safe-T-Beam® pair, see page 19.
OFF	ON/RED/ FLASHING	Door contact in UP or DOWN travel.	Remove obstruction.
		Door component failure detected.	Check door spring, track, rollers, hinges and fixtures. Page 15.
OFF	ON/RED/ STEADY	Thermal cutout.	DO NOT unplug unit. Wait until LED clears before operating.
ON/PURPLE/ STEADY	ON/PURPLE/ STEADY	Component error.	Contact a trained door system technician.
OFF	ON/BLUE/ FLASHING	Door will not open.	Check Sure-Lock™. Sure-Lock™ should be OFF for normal operation (see page 4).
ON/PURPLE/ FLASHING	ON/PURPLE/ FLASHING	Radio receiver error.	Unplug the unit. Wait 5 seconds and plug the unit back in. If problems persist, contact a trained door system technician.

# 7 REPLACEMENT PARTS

## Specify model number of opener when ordering parts

Some hardware listed here shows size and/or type so they may be sourced locally if lost. Complete hardware bags can be ordered separately.

### Chain & Belt Channel

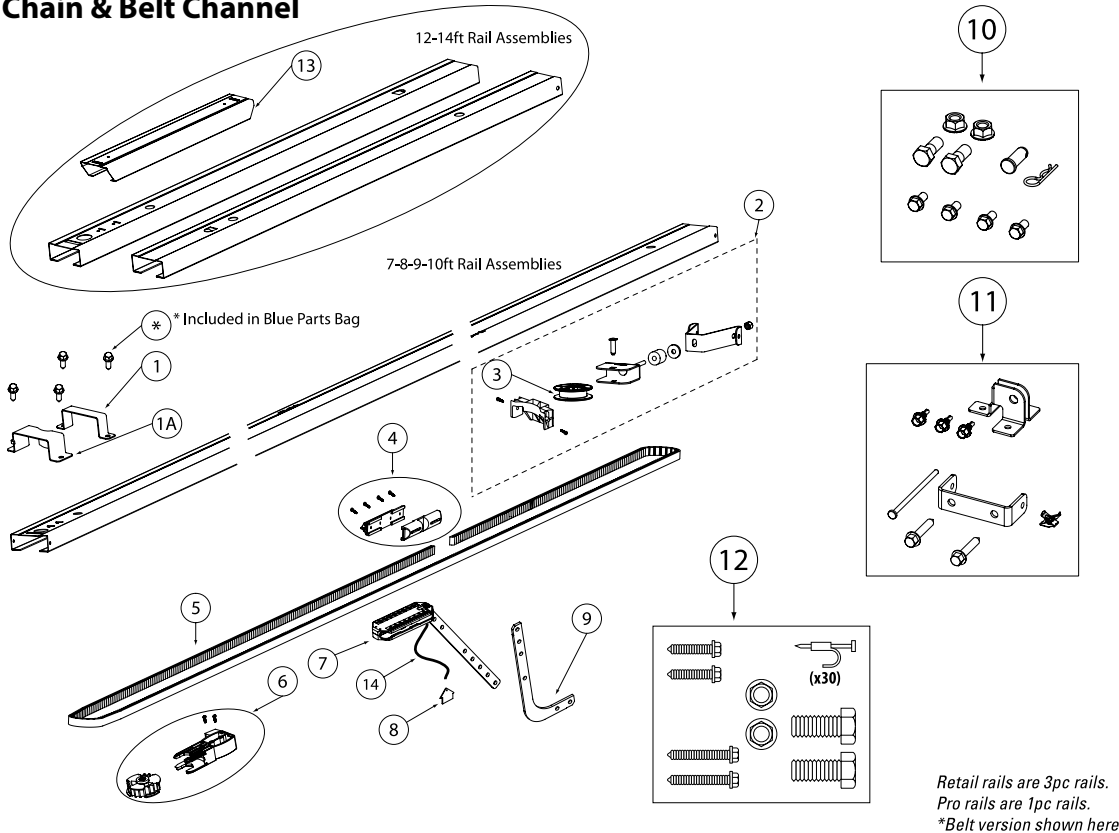

Item	Description	QTY.
1	Head To Rail Bracket (Need 2 for Chain, 1 for Belt)	1
1A	Head To Rail Bracket Belt Guard (for Belt only)	1
2	Tensioner Assembly	1
3	Pulley Tensioner	1
4	Chain Bullet Assembly	1
	Belt Bullet Assembly	1
5	Chain & Bullet Assembly, 7, 8, 10, 12, 14 ft	1
	Belt & Bullet Assembly, 7, 8, 10, 12, 14 ft	1
6	Chain Drive Sprocket Assembly	1
	Belt Drive Sprocket Assembly	1
7	Carriage Assembly, 7 ft Doors	1
	Carriage Assembly, 8 ft Doors	1
	Carriage Assembly, 9, 10, 12, 14 ft Doors	1

8	Carriage Release Handle	1
9	Curved Door Arm	1
10	Installation Parts Pack (Blue Bag)	1
11	Mounting Parts Pack (Orange Bag)	1
12	Hanging Hardware Parts Pack (Green Bag)	1
13	Parts Pack, Rail Connector, 12-14ft Models	1
14	Release Cord Assembly, 7' (32")	1
	Release Cord Assembly, 8' (44")	1
	Release Cord Assembly, 9-14' (116")	1
NS	Rail Support Kit, 12-14 ft only	1
NS	Wire Clips, (50 pcs)	1
NS	Rail Extender Kit, 8' Chain (for 7' Retail Rail)	1
NS	Rail Extender Kit, 8' Belt (for 7' Retail Rail)	1
NS	3PC Service Rail, C-Channel Chain Drive Rail	1
NS	3PC Service Rail, C-Channel Belt Drive Rail	1



## DC Chain/Belt Drive Powerhead

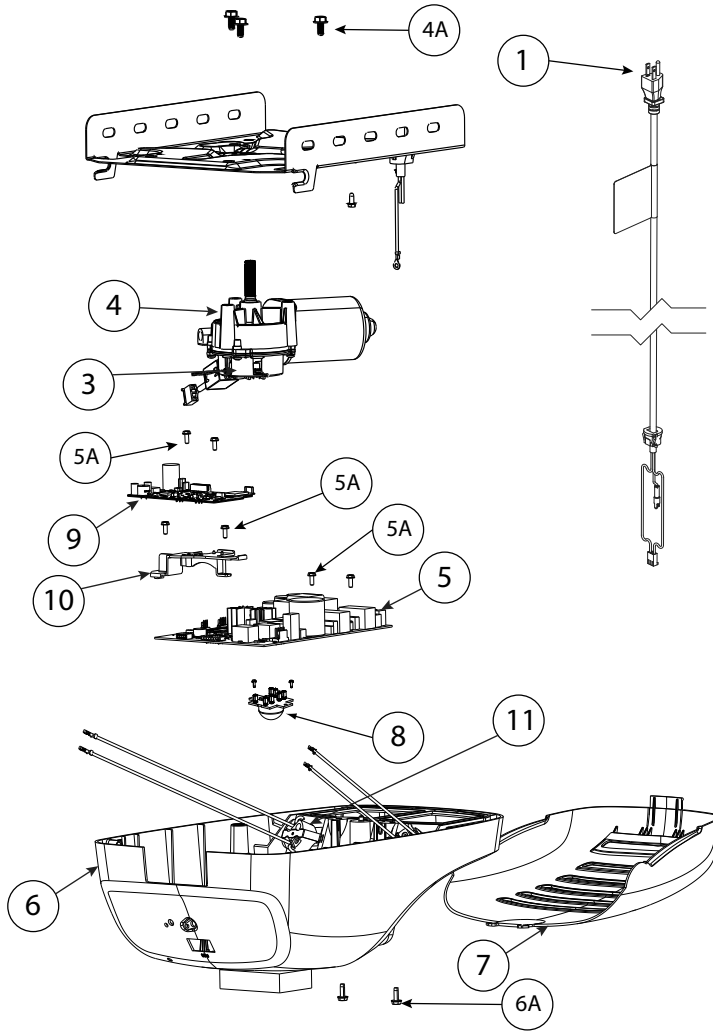

**Specify model number of opener when ordering parts**

Item	Description	QTY.
1	Power Cord Assembly	1
3	Optical Dual Encoder	1
4	Motor Assembly w/Encoder	1
4A	Screw, 6-18 x 3/8, Self Tap	3
5	Circuit Board Assembly	1
5A	Screw, 6-18 x 3/8, Self Tap	3
6	Powerhead Cover	1
6A	Screw, Motor, #10-32 X 1/2	1
7	Light Lens	1
8	Motion Detector Module w/ Screws	1
9	Integrated Aladdin Connect® Module	1
10	iDCM Mounting Bracket	1
11	Light Socket Assembly	2

## DC ScrewDrive Powerhead

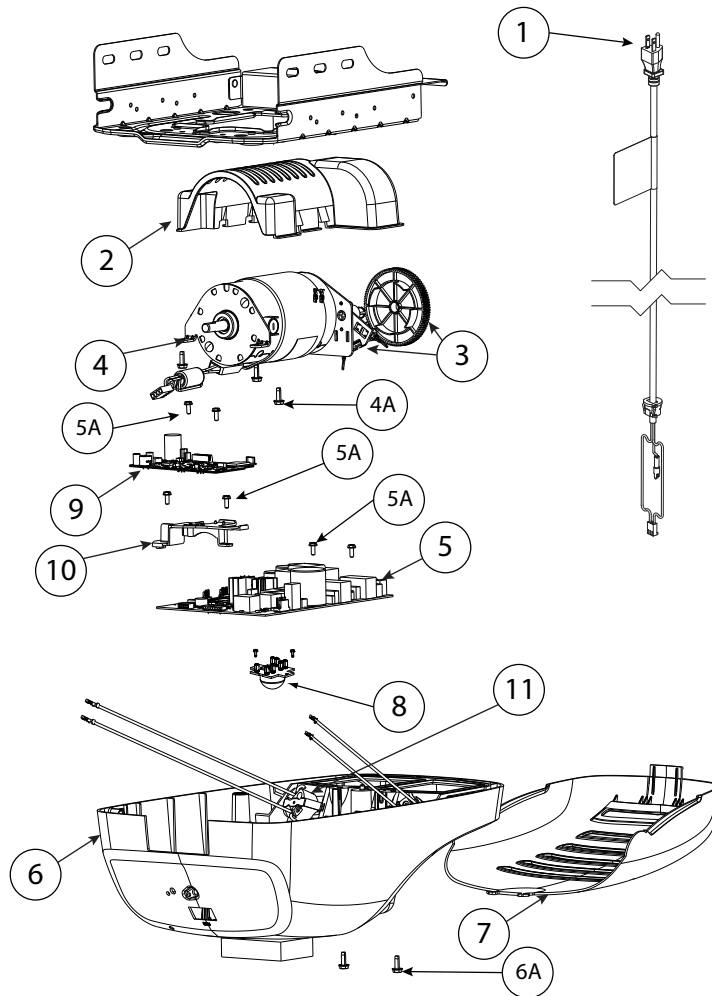

**Specify model number of opener when ordering parts**

Item	Description	QTY.
1	Power Cord Assembly	1
2	Motor Cover Assembly	1
3	Optical Dual Encoder	1
4	Motor Assembly w/Opto-Luctor	1
4A	Screw, Motor, #10-32 X 1/2	3
5	Circuit Board Assembly	1
5A	Screw, 6-18 x 3/8, Self Tap	3
6	Powerhead Cover	1
6A	Screw, Motor, #10-32 X 1/2	1
7	Light Lens	1
8	Motion Detector Module w/ Screws	1
9	Integrated Aladdin Connect® Module	1
10	iDCM Mounting Bracket	1
11	Light Socket Assembly	2

## AC ScrewDrive Powerhead

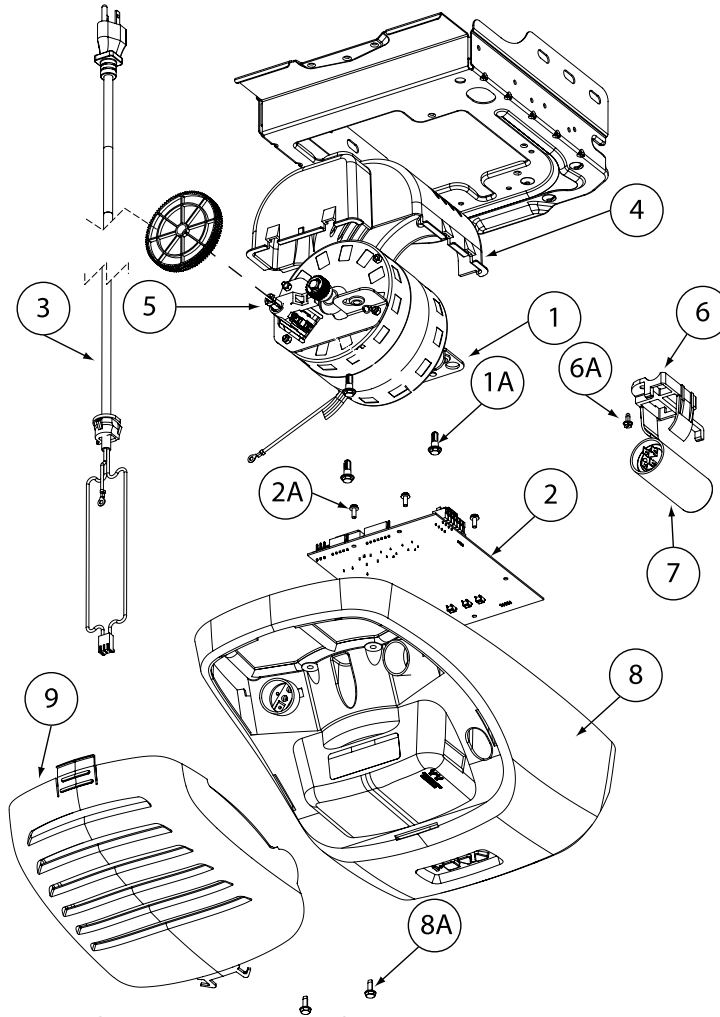

**Specify model number of opener when ordering parts**

Item	Description	QTY.
1	Motor Assembly w/Opto-Luctor, includes screws (Single & Dual Encoder)	1
1A	Screw, motor, M6 x 1-12	3
2	Circuit Board Assembly (Single & Dual Encoder)	1
2	Screw, 6-18 x 3/8, Self Tap	3
3	Power Cord Assembly	1
4	Motor Cover Assembly	1
5	Optical Dual Encoder Repl Assembly (Single & Dual Encoder)	1
6	Capacitor Bracket	1
6A	Screw, 8-32 x 3/8 HHD SLTD TAP	2
7	Capacitor 70 uF	1
8	Powerhead Cover	1
8A	Screw, Motor, #10-32 X 1/2	2
9	Light Lens	1

# Screwdrive Channel

Specify model number of opener when ordering parts

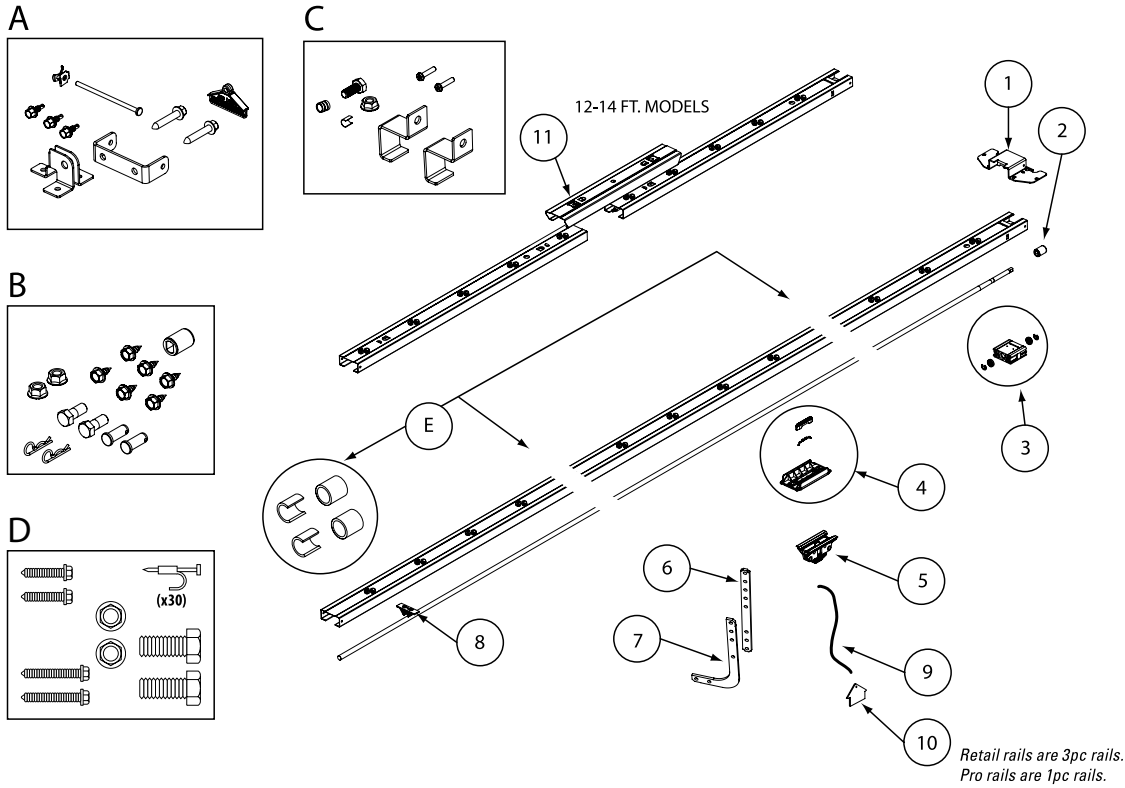

Item	Description	QTY.
1	Mounting Flange, Rail	1
2	Coupler	1
3	Bearing Block Assembly	1
4	Carriage Assembly, Screw Drive	1
5	Shuttle Assembly, Screw Drive	1
6	Straight Door Arm	1
7	Curved Door Arm	1
8	Mount Drive Screw, 7f t. Models	13
	Mount Drive Screw, 8f t. Models	15
	Mount Drive Screw, 10f t. Models	17
	Mount Drive Screw, 12f t. Models	20
	Mount Drive Screw, 14f t. Models	24
9	Emergency Release Cord, 7-8-10 ft Models	1
	Emergency Release Cord, 12-14f t Models	1

10	Carriage Release Handle	1
11	Parts Pack, Rail Connector, 12-14f t Models	1
A	Mounting Parts Pack (Orange Bag)	1
B	Installation Parts Pack (Blue Bag)	1
C	Rail Support Kit, 12-14 ft only	1
D	Hanging Hardware Parts Pack (Green Bag Retail)	1
E	Retaining Clip (Retail)	2
	Collar (Retail)	2
NS	Wire Clips, (50 pcs)	1
NS	8' Rail Extender Kit	1
NS	3PC Service Rail, C-Channel Screw Drive	1



# 8 DASMA SAFETY GUIDELINES



Look for this Safety Alert Symbol below. This symbol indicates a potential personal safety hazard that can result in injury or death.

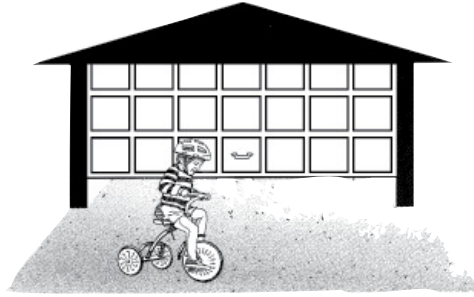

## A GARAGE DOOR IS THE LARGEST MOVING OBJECT IN THE HOME.

These doors are often operated by electric door openers. Proper installation, operation, maintenance, and testing of the garage door and automatic opener are necessary to provide safe, trouble-free operation.

An improperly adjusted garage door or automatic opener can exert deadly force when the door closes. This could lead to serious injury or death from being hit by a closing garage door or from being trapped under the door.



A few simple precautions can protect our family and friends from potential harm. Please take a few minutes to read the following safety and maintenance tips. Refer to your garage door and opener owner's manual for details specific to your garage door and automatic opener.



Do not stand or walk under a moving door! Do not let children or adults play "beat the door."

It is dangerous and can result in serious injury or death. Adults should set a good example. Know how to use the emergency release, in case someone is pinned by the door.



Do not let children play with or use the transmitters or remote controls. Always place or store them out of the reach of children.



# DASMA SAFETY GUIDELINES



**The push button wall control should be out of reach of children.**

(at least 5 feet from the floor) and away from all moving parts. Mount and use the button where you can clearly see the moving garage door.



**GARAGE DOOR OPENERS ARE NOT TOYS.**

Careless operation and allowing children to play with or use garage door opener controls can lead to tragic results. Discuss garage door safety with your children. Explain the danger of being trapped under the door.

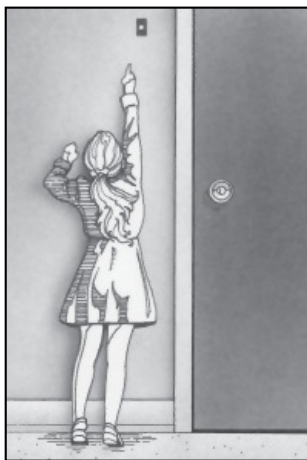

**WHEN USING THE PUSH BUTTON OR TRANSMITTER, KEEP THE DOOR IN SIGHT UNTIL IT COMPLETELY STOPS MOVING.**

Teach children never to play under or near an open garage door.

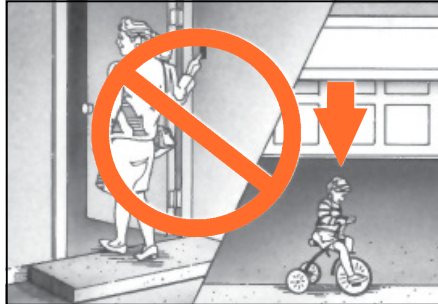

**Teach children to keep their hands and fingers clear of section joints, hinges, track, springs, and other door parts.**

Contact with a moving door or its hardware could cause injury. These injuries can also happen with garage doors that don't have automatic openers.



**National  
Safety  
Council**

This important information is provided by the U.S. Consumer Product Safety Commission, the National Safety Council, and the Industry Coalition for Automatic Garage Door Opener Safety.

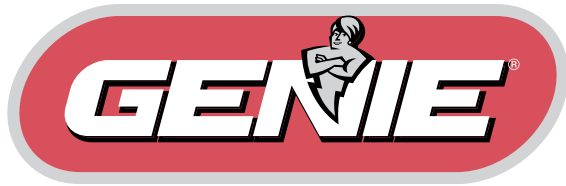

**The Genie Company**  
**1 Door Drive**  
**Mount Hope Ohio 44660**  
**1-800-35-GENIE (354-3643)**  
**[www.geniecompany.com](http://www.geniecompany.com)**